

ALFRED piantana

Bizzarri design

anno 2016

SCHEDA TECNICA - HP128 2N INT

CORPO LAMPADA "A"

materiale metallo
colore nero opaco



CAVO ELETTRICO "C"

materiale telaio
colore bianco/
nero



DISPOSITIVO ELETTRICO

portalampane E27
sorgente luminosa max 1x52w - energy saving
classe energetica da E a A++





PACKAGING

n° colli 1
peso netto/kg 7,7
peso lordo/kg 11,7
imballo/cm 185x40x40

EMISSIONE LUMINOSA

unidirezionale



 diretta
 filtrata
 indiretta
 assenza

CERTIFICAZIONI

IEC 60598-1:2014
EN 60598-1:2015



grado di protezione lampadina

IP20
non inclusa

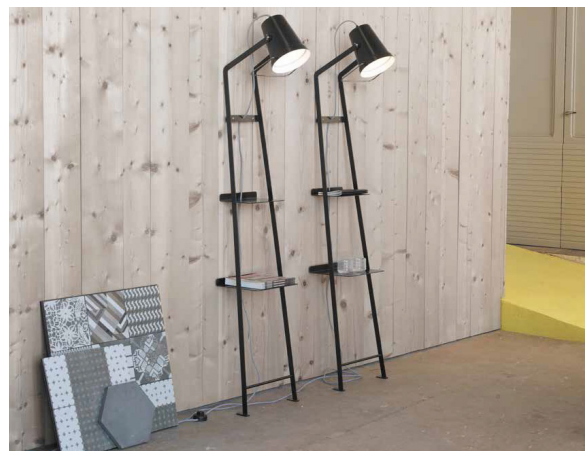
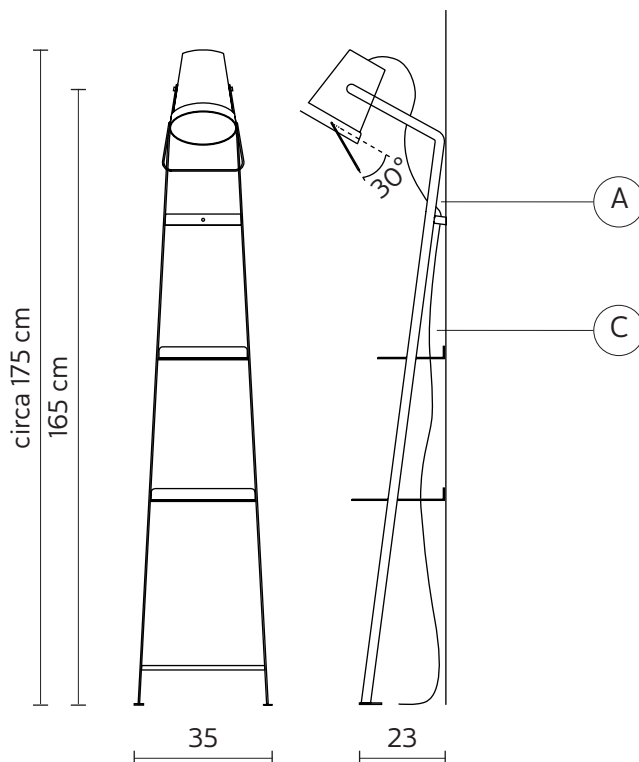

COLLEZIONE disponibile anche nella versione sospensione multipla, singola e applique



HP1281BINT

BACCO lampada da tavolo

Matteo Ugolini design

anno 2017

SCHEMA TECNICA - CT143 1B INT

DIFFUSORE "A"

materiale
colore

vetro
bianco
satinato

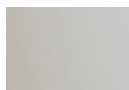

LOGO "B"

materiale
colore

metallo
nichelato



BASE REMOVIBILE "C"

materiale

alluminio

MODULO LED

- Led 3,3W, 3000K - 250lm
- Batterie ricaricabili 4,8Vdc
- Autonomia batterie 6 ore
- Tempo minimo di ricarica batterie 10 ore

CARICABATTERIE SINGOLO

incluso





PACKAGING

n° colli 1
peso netto/kg 0,65
peso lordo/kg 1,2
imballo/cm 12x12x58

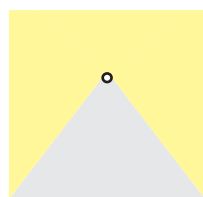
EMISSIONE LUMINOSA

unidirezionale



 diretta
 filtrata
 indiretta
 assenza

CERTIFICAZIONI

IEC 60598-1:2014
EN 60598-1:2015



grado di protezione

IP20

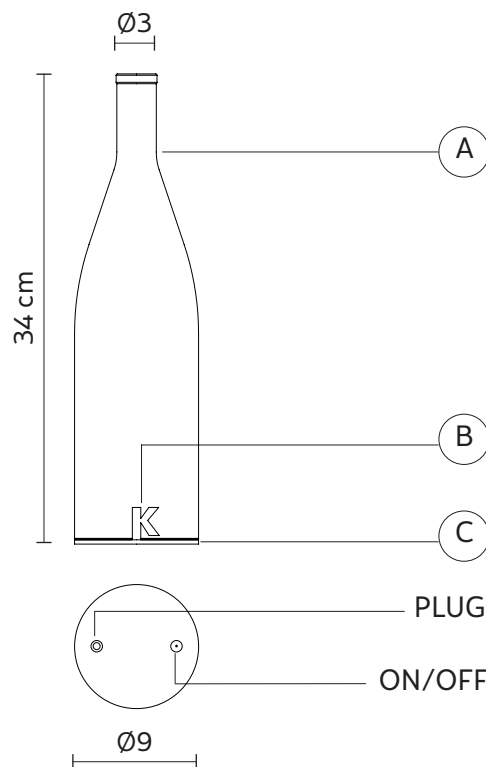

BRILLE lampada da tavolo

Matteo Ugolini design

anno 2017

SCHEDA TECNICA - CT144 1B INT

DIFFUSORE "A"

materiale vetro satinato
colore bianco



BASE "B"

materiale metallo
colore bianco opaco



CAVO ELETTRICO "C"

colore trasparente

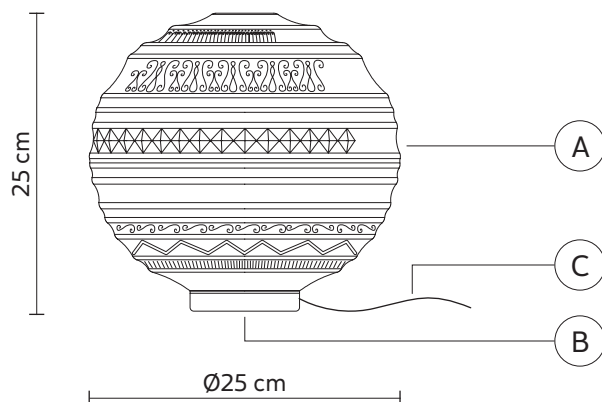

DISPOSITIVO ELETTRICO

portalampade E14
sorgente luminosa 1 x max 52W
classe energetica da E a A++





PACKAGING

n° colli 1
peso netto/kg 1,85
peso lordo/kg 2,8
imballo/cm 35x35x38

EMISSIONE LUMINOSA

unidirezionale



 diretta
 filtrata
 indiretta
 assenza



CERTIFICAZIONI

IEC 60598-1:2008
EN 60598-1:2008 + A11:2009



grado di protezione lampadina

IP20
non inclusa

COLLEZIONE

disponibili anche nella versione sospensione, plafoniera e applique



CT144 2B INT

BRILLE lampada da tavolo

Matteo Ugolini design

anno 2017

SCHEDA TECNICA - CT144 2B INT

DIFFUSORE "A"

materiale vetro satinato
colore bianco

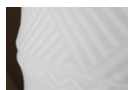

BASE "B"

materiale metallo
colore bianco opaco



CAVO ELETTRICO "C"

colore trasparente



DISPOSITIVO ELETTRICO

portalampade E27
sorgente luminosa 1 x max 105W
classe energetica da E a A++





PACKAGING

n° colli 1
peso netto/kg 5,65
peso lordo/kg 8
imballo/cm 50x50x50

EMISSIONE LUMINOSA

unidirezionale



 diretta
 filtrata
 indiretta
 assenza

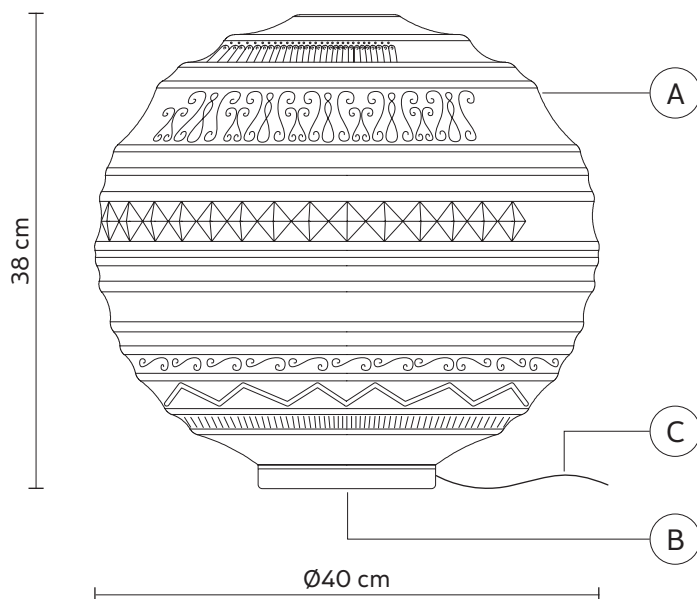

CERTIFICAZIONI

IEC 60598-1:2008
EN 60598-1:2008 + A11:2009



grado di protezione lampadina IP20
non inclusa

COLLEZIONE

disponibili anche nella versione sospensione, plafoniera e applique



CT144 1B INT

BRILLE plafoniera/applique

Matteo Ugolini design

anno 2017

SCHEDA TECNICA - PL144 1B INT

DIFFUSORE "A"

materiale vetro satinato
colore bianco

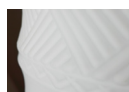

ROSONE "E"

materiale metallo
colore bianco opaco



DISPOSITIVO ELETTRICO

portalampade E14
sorgente luminosa 1 x max 52W
classe energetica da E a A++





PACKAGING

n° colli 1
peso netto/kg 1,85
peso lordo/kg 2,8
imballo/cm 35x35x38

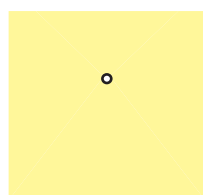
EMISSIONE LUMINOSA

unidirezionale



 diretta
 filtrata
 indiretta
 assenza

CERTIFICAZIONI

IEC 60598-1:2008
EN 60598-1:2008 + A11:2009



grado di protezione lampadina IP20
non inclusa

versione plafoniera

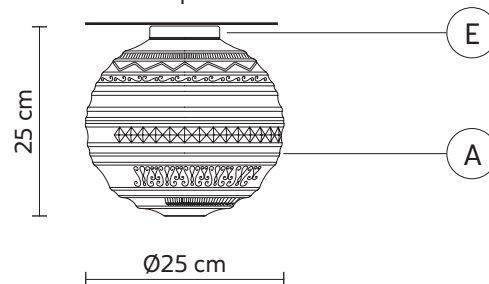

versione applique

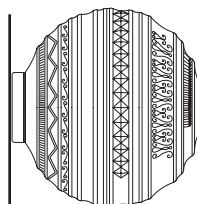

COLLEZIONE

disponibili anche nella versione sospensione e da tavolo

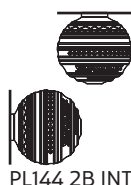

PL144 2B INT

BRILLE plafoniera/applique

Matteo Ugolini design

anno 2017

SCHEDA TECNICA - PL144 2B INT

DIFFUSORE "A"

materiale vetro satinato
colore bianco

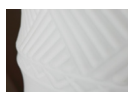

ROSONE "E"

materiale metallo
colore bianco opaco



DISPOSITIVO ELETTRICO

portalampade E27
sorgente luminosa 1 x max 105W
classe energetica da E a A++





PACKAGING

n° colli 1
peso netto/kg 5,5
peso lordo/kg 7,6
imballo/cm 50x50x50

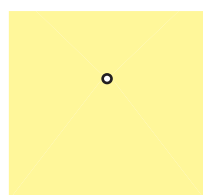
EMISSIONE LUMINOSA

unidirezionale



 diretta
 filtrata
 indiretta
 assenza

CERTIFICAZIONI

IEC 60598-1:2008
EN 60598-1:2008 + A11:2009



grado di protezione lampadina

IP20
non inclusa

versione plafoniera

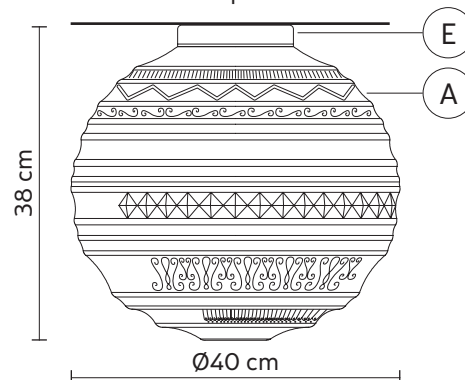

versione applique

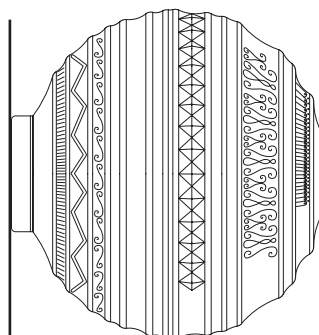

COLLEZIONE

disponibili anche nella versione sospensione e da tavolo



PL144 1B INT

BRILLE sospensione

Matteo Ugolini design

anno 2017

SCHEDA TECNICA - SE144 1B INT

DIFFUSORE "A"

materiale vetro satinato
colore bianco



ROSONE "E"

materiale metallo
colore bianco opaco



CAVO ELETTRICO "C"

colore trasparente



CAVO DI SOSPENSIONE "F"

materiale acciaio

DISPOSITIVO ELETTRICO

portalampane E14
sorgente luminosa 1 x max 52W
classe energetica da E a A++

PACKAGING

n° colli 1
peso netto/kg 2,25
peso lordo/kg 3,3
imballo/cm 35x35x38

EMISSIONE LUMINOSA

unidirezionale



CERTIFICAZIONI

IEC 60598-1:2008
EN 60598-1:2008 + A11:2009



grado di protezione lampadina IP20
non inclusa

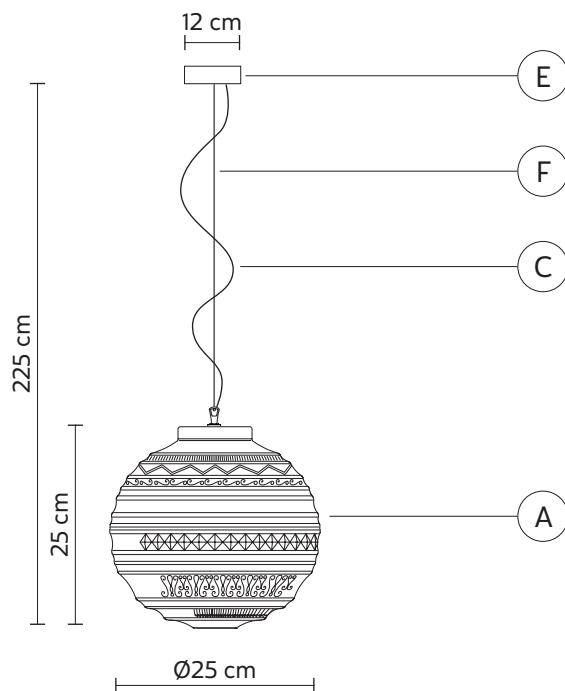

COLLEZIONE

disponibili anche nella versione plafoniera/applique e da tavolo



SE144 2B INT

BRILLE sospensione

Matteo Ugolini design

anno 2017

SCHEDA TECNICA - SE144 2B INT

DIFFUSORE "A"

materiale vetro satinato
colore bianco



ROSONE "E"

materiale metallo
colore bianco opaco



CAVO ELETTRICO "C"

colore trasparente



CAVO DI SOSPENSIONE "F"

materiale acciaio

DISPOSITIVO ELETTRICO

portalampade E27
sorgente luminosa 1 x max 105W
classe energetica da E a A++

PACKAGING

n° colli 1
peso netto/kg 6
peso lordo/kg 8,5
imballo/cm 50x50x50

EMISSIONE LUMINOSA

unidirezionale



CERTIFICAZIONI

IEC 60598-1:2008
EN 60598-1:2008 + A11:2009



grado di protezione lampadina IP20
non inclusa

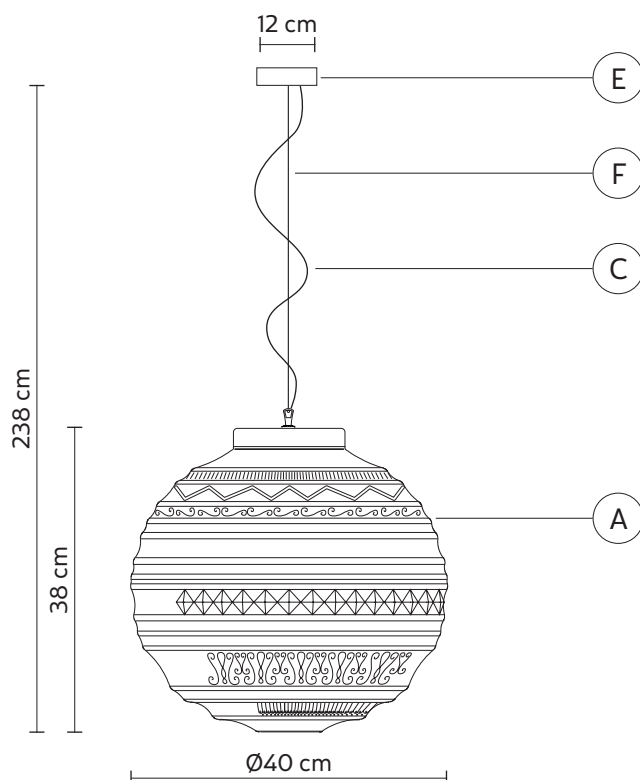

COLLEZIONE

disponibili anche nella versione plafoniera/applique e da tavolo



SE144 1B INT

CUBANO applique

Matteo Ugolini design

anno 2017

SCHEDA TECNICA - AP142 1B INT

CORPO LAMPADA "A"

materiale
colore

ceramica
bianco



DISPOSITIVO ELETTRICO

portalampade
sorgente luminosa
classe energetica

E27
1 x max 52W
da E a A++

PACKAGING



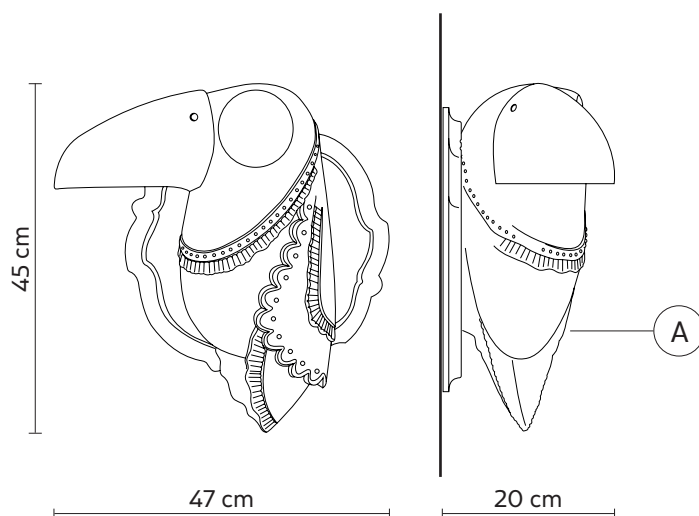

n° colli 1
peso netto/kg 4,35
peso lordo/kg 6
imballo/cm 56x56x32



EMISSIONE LUMINOSA

unidirezionale



 diretta
 filtrata
 indiretta
 assenza



CERTIFICAZIONI

IEC 60598-1:2008
EN 60598-1:2008 + A11:2009



grado di protezione
lampadina

IP20
opzionale



articolo **700B**
filamenti di tungsteno
E27 - 25W - ≤ 60 lumen
classe E

DON'T TOUCH lampada da terra

Matteo Ugolini design

anno 2018

SCHEDA TECNICA - HP153 AB EXT

BASE "B"

materiale tecnopolimero
colore grigio opaco

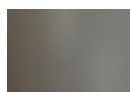

BACCHETTE "A"

materiale PVC
colore bianco opaco



CAVO ELETTRICO "C"

colore nero



ACCESSORIO ANELLO "O"

materiale silicone

DISPOSITIVO ELETTRICO

sorgente luminosa LED
1 x 29W, 2600 lumen
3000K CRI ≥ 80
classe A+



PACKAGING

n° colli 2
peso netto/kg 13 (A+B)
peso lordo/kg 16 (A+B)
imballo/cm 10x10x140 (A) - 5x5x32 (B)

EMISSIONE LUMINOSA

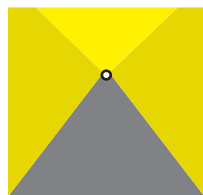
unidirezionale



 diretta
 filtrata
 indiretta
 assenza

CONFORME ALLE

IEC 60598-1:2014
EN 60598-1:2015



grado di protezione IP67
LED incluso

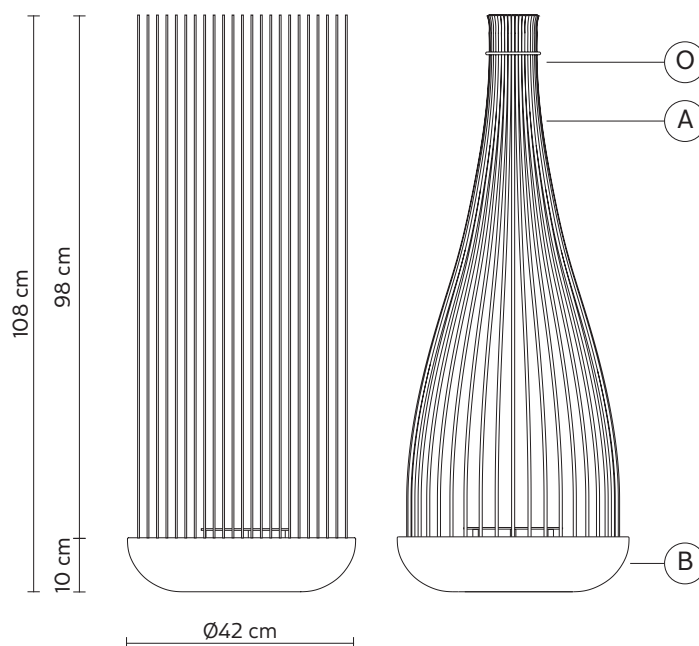

COLLEZIONE

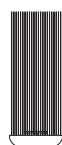

HP153 AB INT



HP153 BB INT



HP153 BB EXT

GANGSTER sospensione

Matteo Ugolini design

anno 2013

SCHEDA TECNICA - SE641BB

CORPO LAMPADA "A"

materiale ceramica
colore bianco lucido



ROSONE "E"

materiale metallo
colore bianco lucido

CAVO ELETTRICO "C"

materiale PVC
colore trasparente

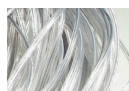

FUNE DI SOSPENSIONE "F"

materiale acciaio

DISPOSITIVO ELETTRICO

portalampade E27
sorgente luminosa max 1x105w
classe energetica da E a A++

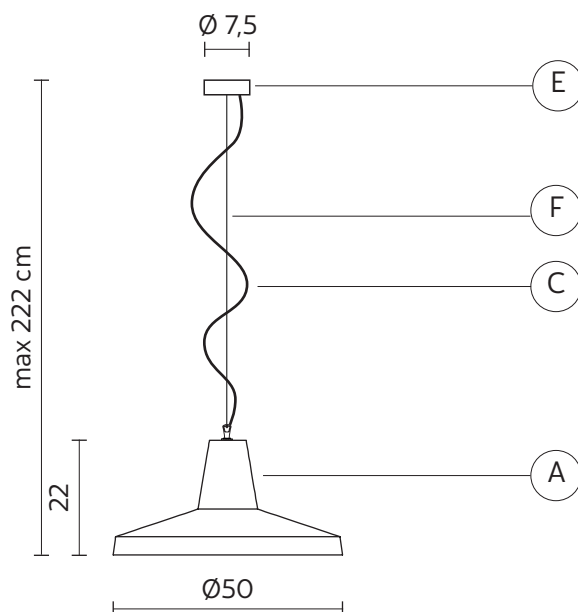





PACKAGING

n° colli 1
peso netto/kg 4,05
peso lordo/kg 8,9
imballo/cm 36x62x62

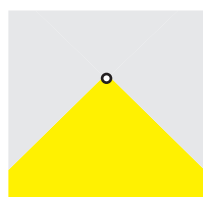
EMISSIONE LUMINOSA

unidirezionale



 diretta
 filtrata
 indiretta
 assenza

CERTIFICAZIONI

IEC 60598-1:2008
EN 60598-1:2008 + A11:2009



grado di protezione lampadina

IP20
non inclusa



COLLEZIONE

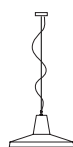

SE641BR

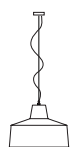

SE642BB

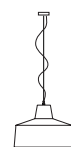

SE642BR

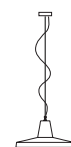

SE643BB

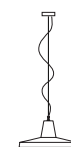

SE643BR

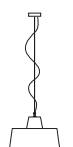

SE644BB

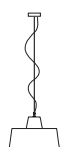

SE644BR

GANGSTER sospensione

Matteo Ugolini design

anno 2013

SCHEDA TECNICA - SE641BR

CORPO LAMPADA "A"

materiale ceramica
colore (esterno) bianco lucido



materiale ceramica
colore (interno) bronzo lucido



ROSONE "E"

materiale metallo
colore bianco lucido

CAVO ELETTRICO "C"

materiale PVC
colore trasparente

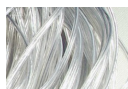

FUNE DI SOSPENSIONE "F"

materiale acciaio

DISPOSITIVO ELETTRICO

portalampade E27
sorgente luminosa max 1x105w
classe energetica da E a A++





PACKAGING

n° colli 1
peso netto/kg 4,05
peso lordo/kg 8,9
imballo/cm 38x62x62

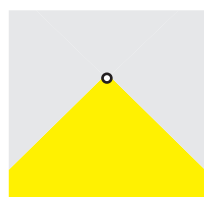
EMISSIONE LUMINOSA

unidirezionale



 diretta
 filtrata
 indiretta
 assenza

CERTIFICAZIONI

IEC 60598-1:2008
EN 60598-1:2008 + A11:2009



grado di protezione lampadina

IP20
non inclusa

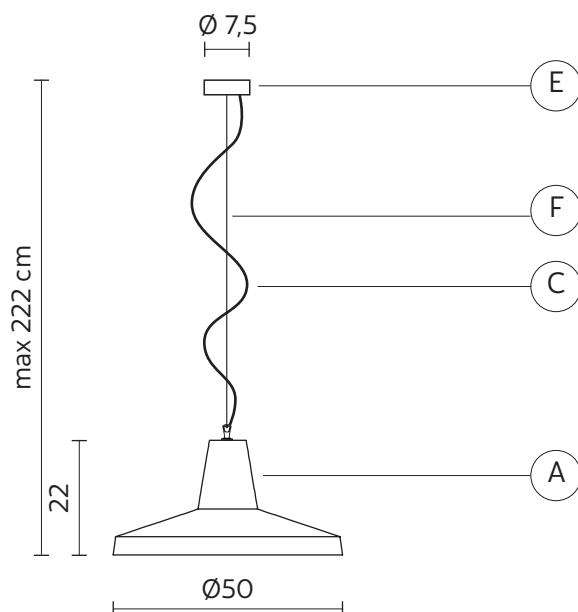

COLLEZIONE

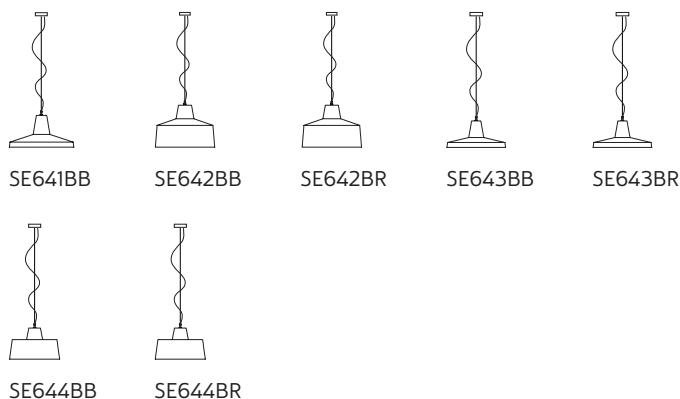

GANGSTER sospensione

Matteo Ugolini design

anno 2013

SCHEDA TECNICA - SE642BB

CORPO LAMPADA "A"

materiale ceramica
colore bianco lucido



ROSONE "E"

materiale metallo
colore bianco lucido

CAVO ELETTRICO "C"

materiale PVC
colore trasparente

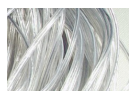

FUNE DI SOSPENSIONE "F"

materiale acciaio

DISPOSITIVO ELETTRICO

portalampade E27
sorgente luminosa max 1x105w
classe energetica da E a A++





PACKAGING

n° colli 1
peso netto/kg 6,7
peso lordo/kg 12
imballo/cm 48x62x62

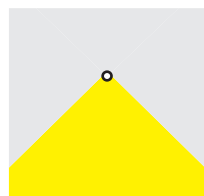
EMISSIONE LUMINOSA

unidirezionale



 diretta
 filtrata
 indiretta
 assenza

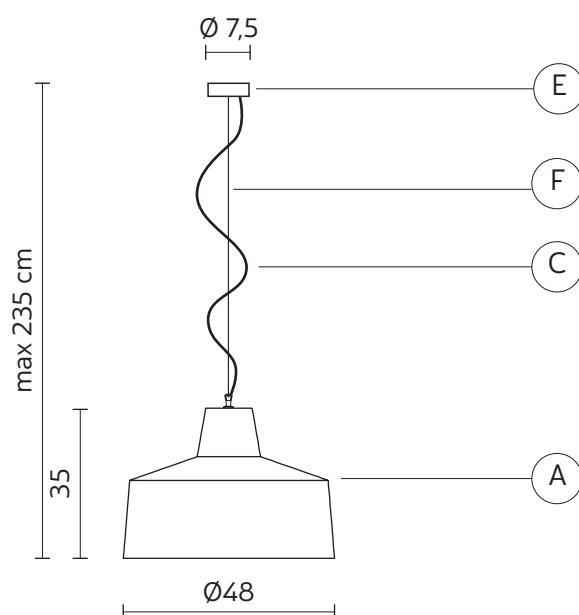

CERTIFICAZIONI

IEC 60598-1:2008
EN 60598-1:2008 + A11:2009



grado di protezione lampadina IP20
non inclusa

COLLEZIONE

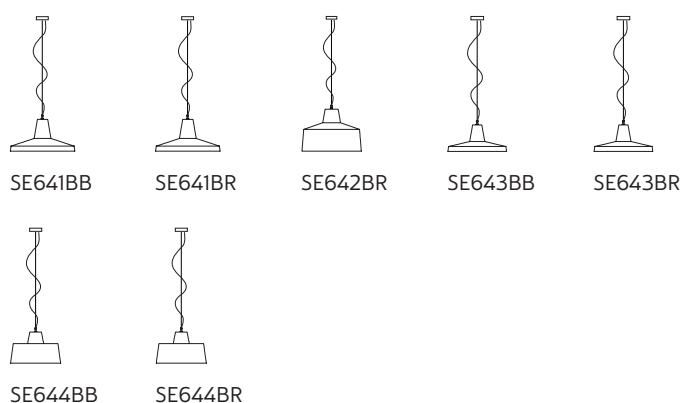

GANGSTER sospensione

Matteo Ugolini design

anno 2013

SCHEDA TECNICA - SE642BR

CORPO LAMPADA "A"

materiale ceramica
colore (esterno) bianco lucido



materiale ceramica
colore (interno) bronzo lucido



ROSONE "E"

materiale metallo
colore bianco lucido

CAVO ELETTRICO "C"

materiale PVC
colore trasparente

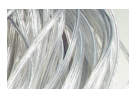

FUNE DI SOSPENSIONE "F"

materiale acciaio

DISPOSITIVO ELETTRICO

portalampade E27
sorgente luminosa max 1x105w
classe energetica da E a A++





PACKAGING

n° colli 1
peso netto/kg 6,7
peso lordo/kg 12
imballo/cm 48x62x62

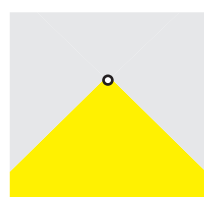
EMISSIONE LUMINOSA

unidirezionale



 diretta
 filtrata
 indiretta
 assenza

CERTIFICAZIONI

IEC 60598-1:2008
EN 60598-1:2008 + A11:2009



grado di protezione lampadina IP20
non inclusa

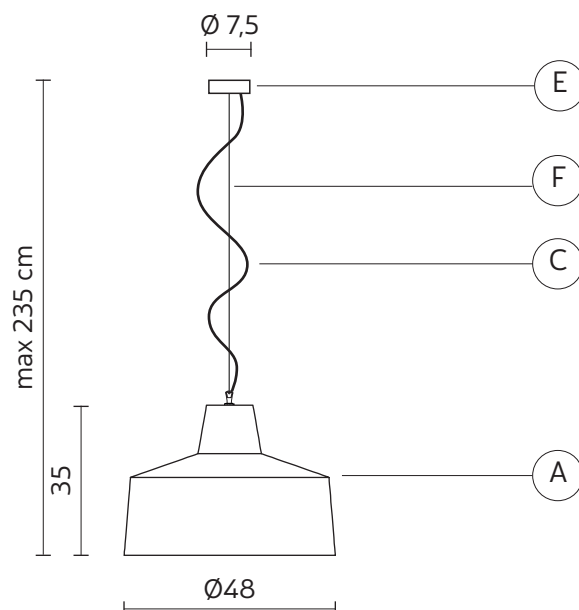

COLLEZIONE

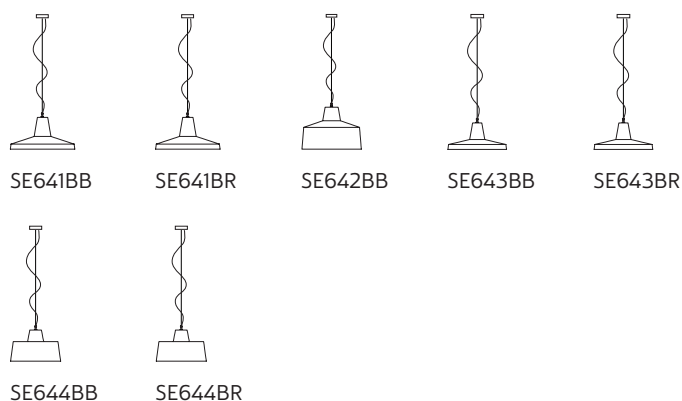

GANGSTER sospensione

Matteo Ugolini design

anno 2013

SCHEDA TECNICA - SE643BB

CORPO LAMPADA "A"

materiale ceramica
colore bianco lucido



ROSONE "E"

materiale metallo
colore bianco lucido

CAVO ELETTRICO "C"

materiale PVC
colore trasparente

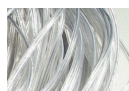

FUNE DI SOSPENSIONE "F"

materiale acciaio

DISPOSITIVO ELETTRICO

portalampade E27
sorgente luminosa max 1x70w
classe energetica da E a A++

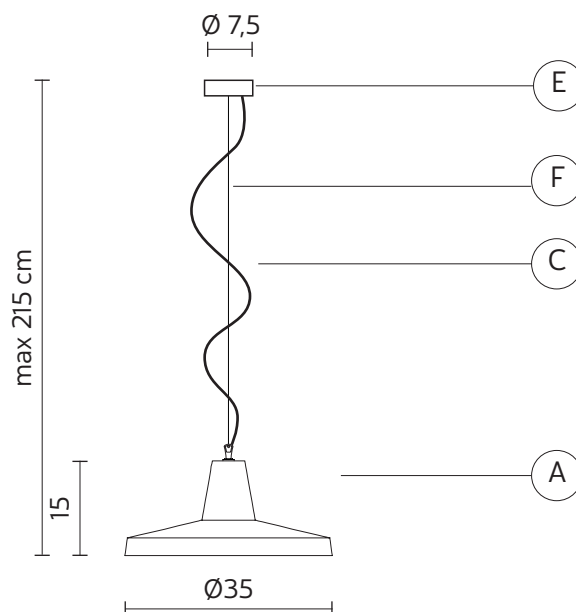





PACKAGING

n° colli 1
peso netto/kg 2,1
peso lordo/kg 3,3
imballo/cm 31x36x36

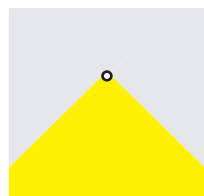
EMISSIONE LUMINOSA

unidirezionale



 diretta
 filtrata
 indiretta
 assenza

CERTIFICAZIONI

IEC 60598-1:2008
EN 60598-1:2008 + A11:2009



grado di protezione lampadina IP20
non inclusa



COLLEZIONE

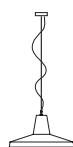

SE641BB

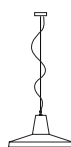

SE641BR

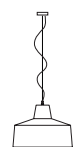

SE642BB



SE642BR

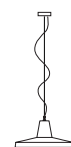

SE643BR

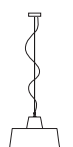

SE644BB

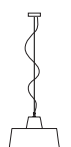

SE644BR

GANGSTER sospensione

Matteo Ugolini design

anno 2013

SCHEDA TECNICA - SE643BR

CORPO LAMPADA "A"

materiale ceramica
colore (esterno) bianca



materiale ceramica
colore (interno) bronzo



ROSONE "E"

materiale metallo
colore bianco lucido

CAVO ELETTRICO "C"

materiale PVC
colore trasparente

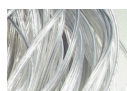

FUNE DI SOSPENSIONE "F"

materiale acciaio

DISPOSITIVO ELETTRICO

portalampade E27
sorgente luminosa max 1x70w
classe energetica da E a A++





PACKAGING

n° colli 1
peso netto/kg 2,1
peso lordo/kg 3,3
imballo/cm 31x36x36

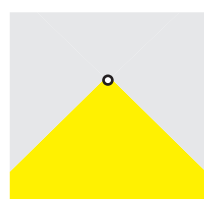
EMMISSIONE LUMINOSA

unidirezionale



 diretta
 filtrata
 indiretta
 assenza

CERTIFICAZIONI

IEC 60598-1:2008
EN 60598-1:2008 + A11:2009



grado di protezione lampadina

IP20
non inclusa

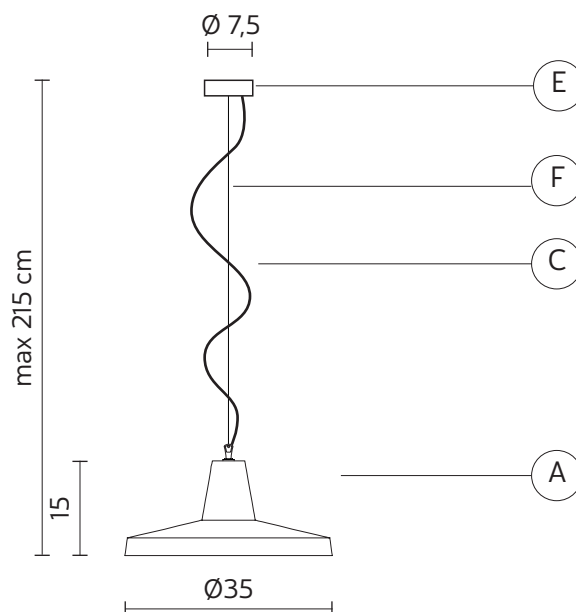

COLLEZIONE

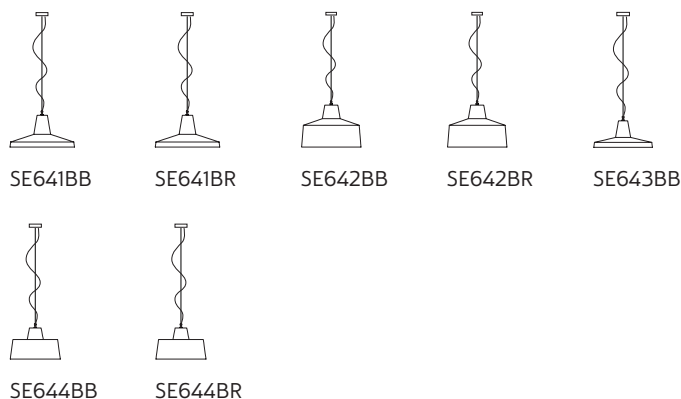

GANGSTER sospensione

Matteo Ugolini design

anno 2013

SCHEDA TECNICA - SE644BB

CORPO LAMPADA "A"

materiale	ceramica	
colore	bianca	

ROSONE "E"

materiale	metallo
colore	bianco lucido

CAVO ELETTRICO "C"

materiale	PVC	
colore	trasparente	

FUNE DI SOSPENSIONE "F"

materiale	acciaio
-----------	---------

DISPOSITIVO ELETTRICO

portalampade	E27
sorgente luminosa	max 1x70w
classe energetica	da E a A++

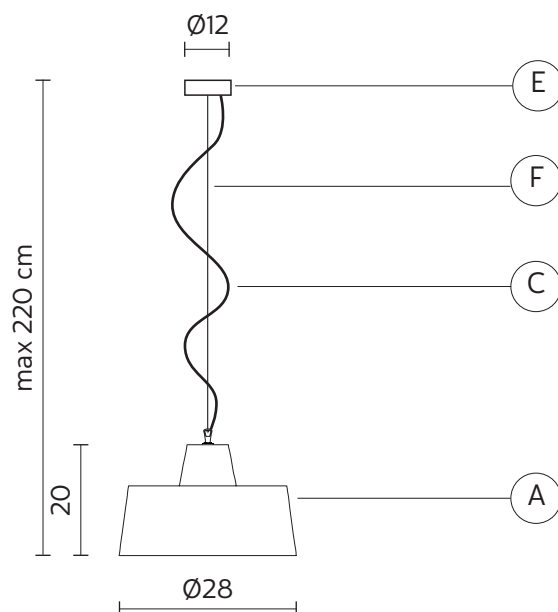

PACKAGING

n° colli	1
peso netto/kg	2,4
peso lordo/kg	4,2
imballo/cm	33x42x42

EMISSIONE LUMINOSA

unidirezionale

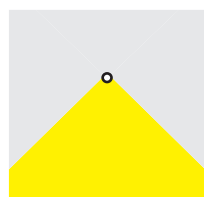

	diretta
	filtrata
	indiretta
	assenza

CERTIFICAZIONI

IEC	60598-1:2008
EN	60598-1:2008 + A11:2009



grado di protezione lampadina	IP20 non inclusa
-------------------------------	---------------------



COLLEZIONE

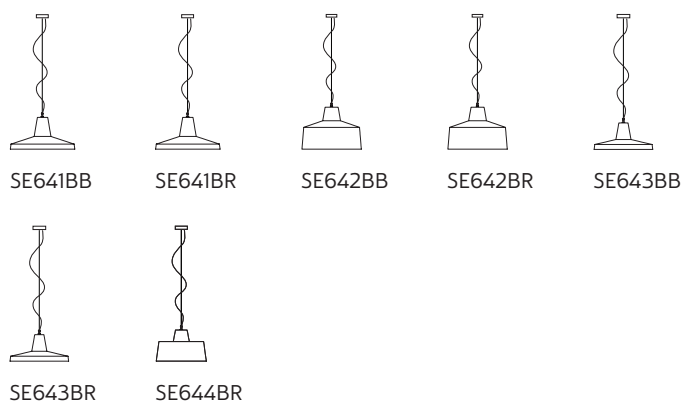



GHEBO sospensione

Luca De Bona e Dario De Meo design

anno 2017

SCHEMA TECNICA - SE146 1N INT

STRUTTURA "A"

materiale	metallo	
colore	nero semilucido	
materiale	vetro artistico	
colore	trasparente	

BOBECHE "D"

materiale	vetro artistico	
colore	trasparente	

BARRA TRAFORATA "B"

materiale	metallo
colore	nero semilucido

CAVO ELETTRICO "C"

colore	trasparente	
--------	-------------	--

DISPOSITIVO ELETTRICO

portalampane	E14
sorgente luminosa	6 x max 42W
classe energetica	da E a A++

PACKAGING

n° colli	1
peso netto/kg	4,6
peso lordo/kg	
imballo/cm	

EMISSIONE LUMINOSA

unidirezionale



CERTIFICAZIONI

IEC	60598-1:2008
EN	60598-1:2008 + A11:2009



grado di protezione lampadina	IP20 non incluse
----------------------------------	---------------------

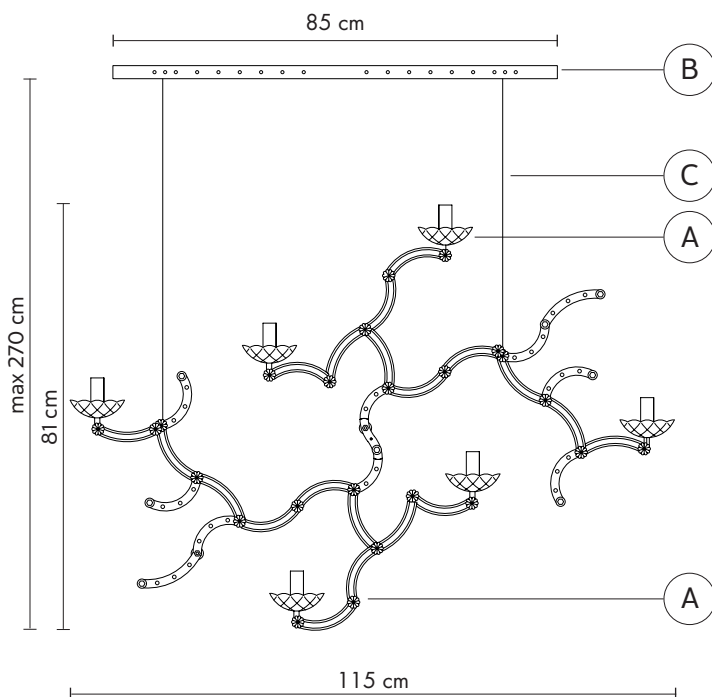

COLLEZIONE

disponibili anche nella versione applique

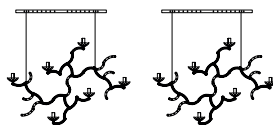

SE146 1B INT SE146 1N INT

GINGER sospensione

Edmondo Testaguzza design

anno 2015

SCHEDA TECNICA - SE116 1A INT

CORPO LAMPADA "A"

materiale	vetro	
colore	paglierino	

ROSONE "E"

materiale	metallo
colore	trasparente

CAVO ELETTRICO "C"

materiale	telato	
colore	nero	

FUNE DI SOSPENSIONE "F"

materiale	acciaio
-----------	---------

DISPOSITIVO ELETTRICO

portalampade	E27
sorgente luminosa	max 1x77w
classe energetica	da E a A++





PACKAGING

n° colli	1
peso netto/kg	2,8
peso lordo/kg	4,1
imballo/cm	43x42x32

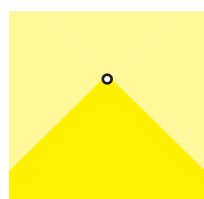
EMISSIONE LUMINOSA

unidirezionale



	diretta
	filtrata
	indiretta
	assenza

CERTIFICAZIONI

IEC	60598-1:2008
EN	60598-1:2008 + A11:2009



grado di protezione lampadina	IP20 non inclusa
-------------------------------	---------------------

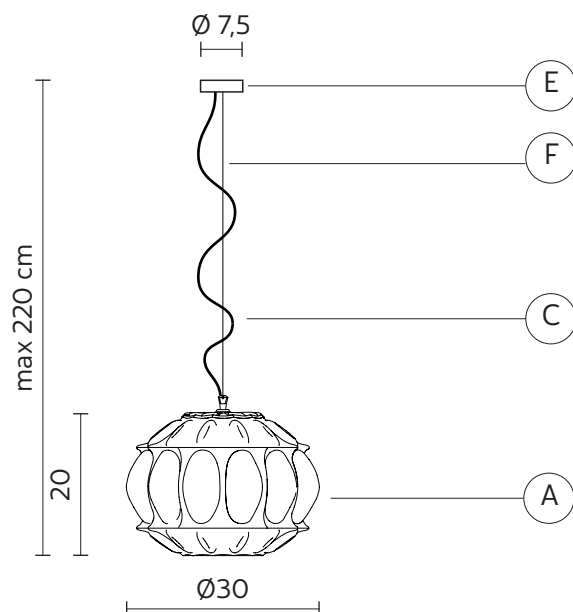

COLLEZIONE

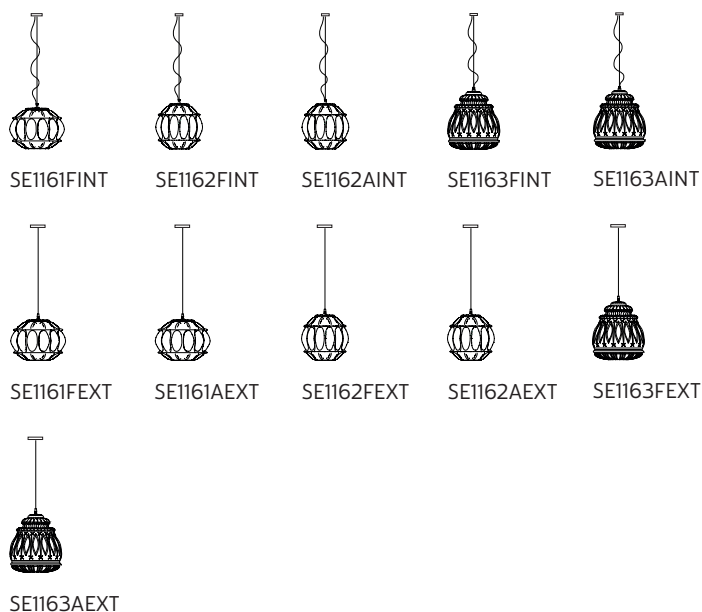

GINGER sospensione

Edmondo Testaguzza design

anno 2015

SCHEDA TECNICA - SE116 1F INT

CORPO LAMPADA "A"

materiale
colore

vetro
fumè



ROSONE "E"

materiale
colore

metallo
trasparente

CAVO ELETTRICO "C"

materiale
colore

telato
nero



FUNE DI SOSPENSIONE "F"

materiale

acciaio

DISPOSITIVO ELETTRICO

portalampade
sorgente luminosa
classe energetica

E27
max 1x77w
da E a A++

PACKAGING

n° colli
peso netto/kg
peso lordo/kg
imballo/cm

1
2,8
4,1
43x42x32

EMISSIONE LUMINOSA

unidirezionale

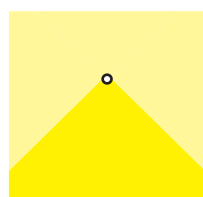

- diretta
- filtrata
- indiretta
- assenza

CERTIFICAZIONI

IEC 60598-1:2008
EN 60598-1:2008 + A11:2009



grado di protezione
lampadina

IP20
non inclusa

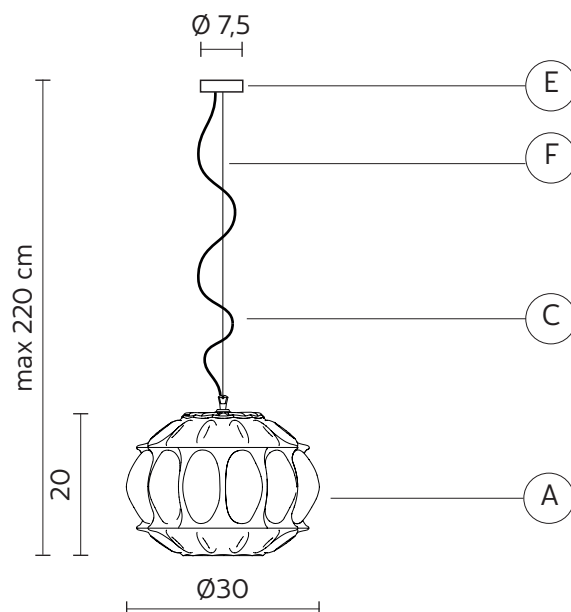

COLLEZIONE

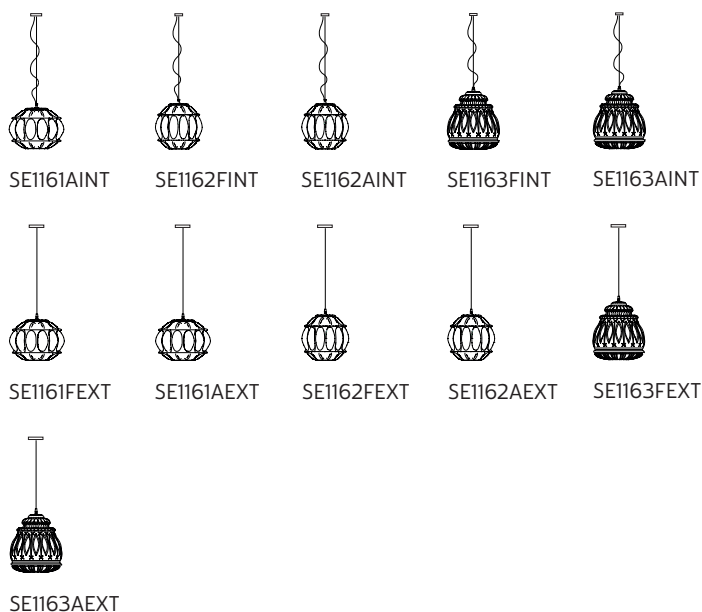

GINGER sospensione

Edmondo Testaguzza design

anno 2015

SCHEMA TECNICA - SE116 2A INT

CORPO LAMPADA "A"

materiale	vetro	
colore	paglierino	

ROSONE "E"

materiale	metallo
colore	trasparente

CAVO ELETTRICO "C"

materiale	telato	
colore	nero	

FUNE DI SOSPENSIONE "F"

materiale	acciaio
-----------	---------

DISPOSITIVO ELETTRICO

portalampade	E27
sorgente luminosa	max 1x77w
classe energetica	da E a A++

PACKAGING

n° colli	1
peso netto/kg	2,9
peso lordo/kg	4,2
imballo/cm	38x38x42

EMISSIONE LUMINOSA

unidirezionale



CERTIFICAZIONI

IEC	60598-1:2008
EN	60598-1:2008 + A11:2009



grado di protezione lampadina	IP20 non inclusa
-------------------------------	---------------------

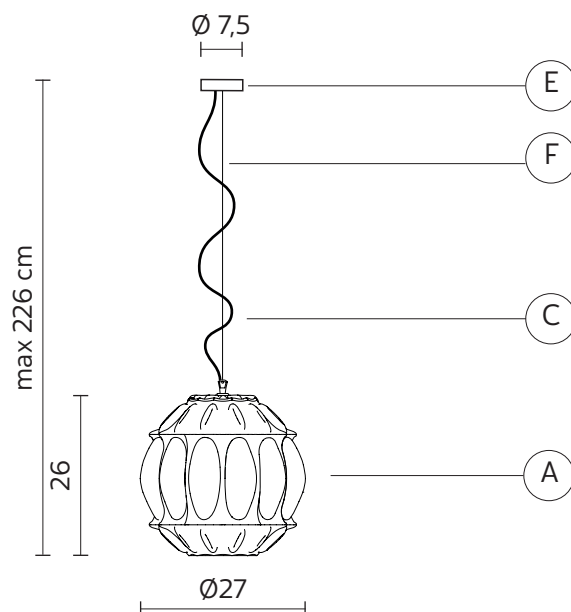

COLLEZIONE

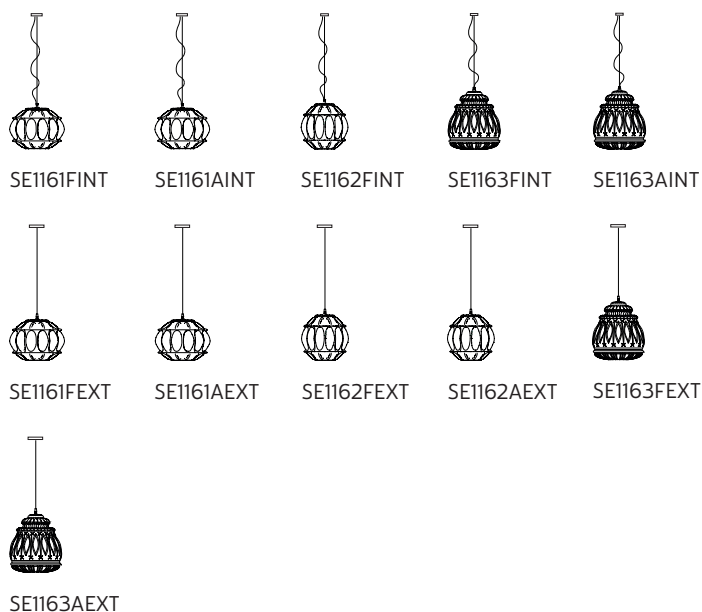

GINGER sospensione

Edmondo Testaguzza design

anno 2015

SCHEDA TECNICA - SE116 2F INT

CORPO LAMPADA "A"

materiale
colore

vetro
fumè



ROSONE "E"

materiale
colore

metallo
trasparente

CAVO ELETTRICO "C"

materiale
colore

telato
nero



FUNE DI SOSPENSIONE "F"

materiale

acciaio

DISPOSITIVO ELETTRICO

portalampade
sorgente luminosa
classe energetica

E27
max 1x77w
da E a A++

PACKAGING





n° colli
peso netto/kg
peso lordo/kg
imballo/cm

1
2,9
4,2
38x38x42

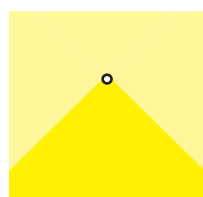
EMISSIONE LUMINOSA

unidirezionale



 diretta
 filtrata
 indiretta
 assenza

CERTIFICAZIONI

IEC 60598-1:2008
EN 60598-1:2008 + A11:2009



grado di protezione
lampadina

IP20
non inclusa

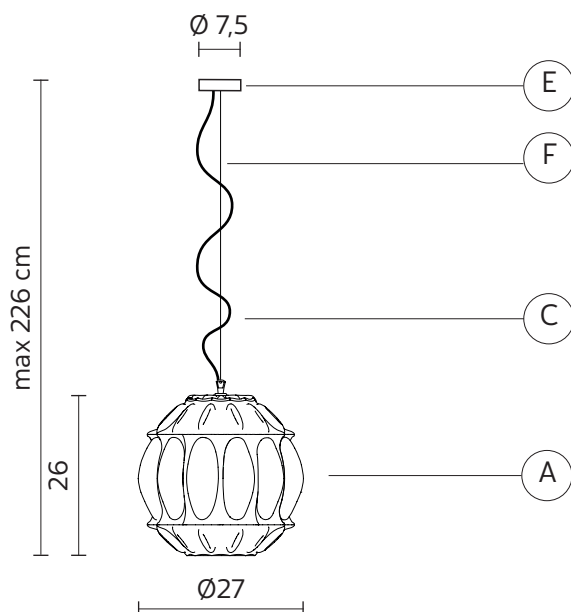

COLLEZIONE

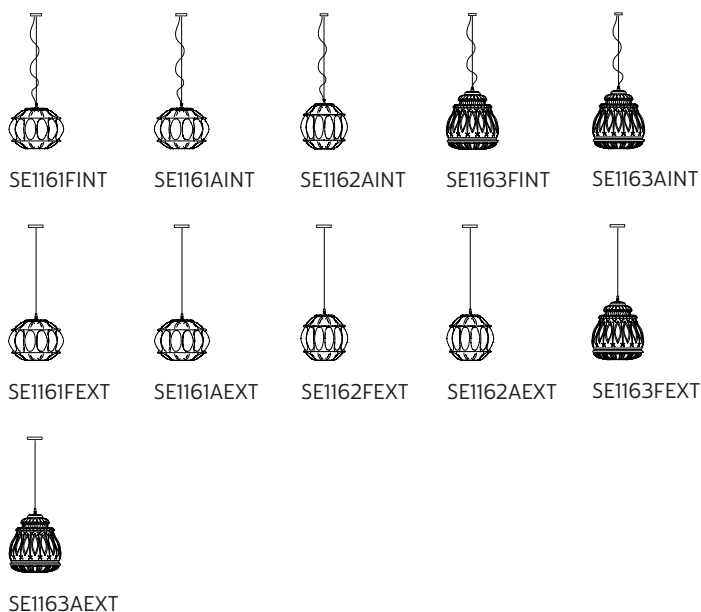

GINGER sospensione

Edmondo Testaguzza design

anno 2015

SCHEMA TECNICA - SE116 3A INT

CORPO LAMPADA "A"

materiale	vetro	
colore	paglierino	

ROSONE "E"

materiale	metallo
colore	trasparente

CAVO ELETTRICO "C"

materiale	telato	
colore	nero	

FUNE DI SOSPENSIONE "F"

materiale	acciaio
-----------	---------

DISPOSITIVO ELETTRICO

portalampane	E27
sorgente luminosa	max 1x77w
classe energetica	da E a A++

PACKAGING

n° colli	1
peso netto/kg	5
peso lordo/kg	9
imballo/cm	47x47x47

EMISSIONE LUMINOSA

unidirezionale



CERTIFICAZIONI

IEC 60598-1:2008
EN 60598-1:2008 + A11:2009



grado di protezione lampadina IP20
non inclusa

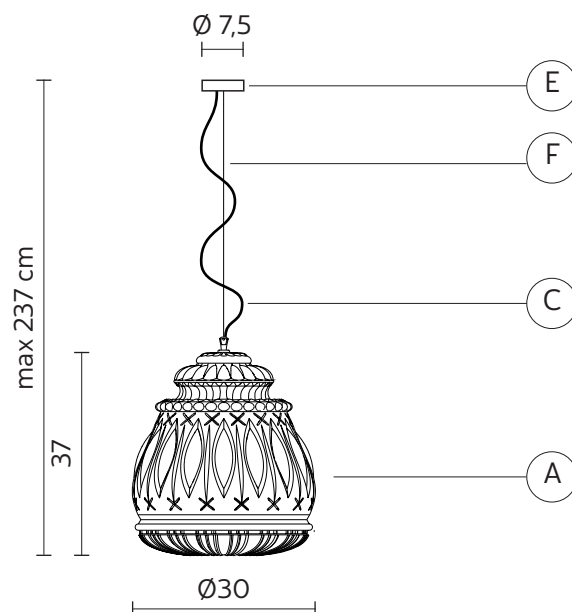

COLLEZIONE

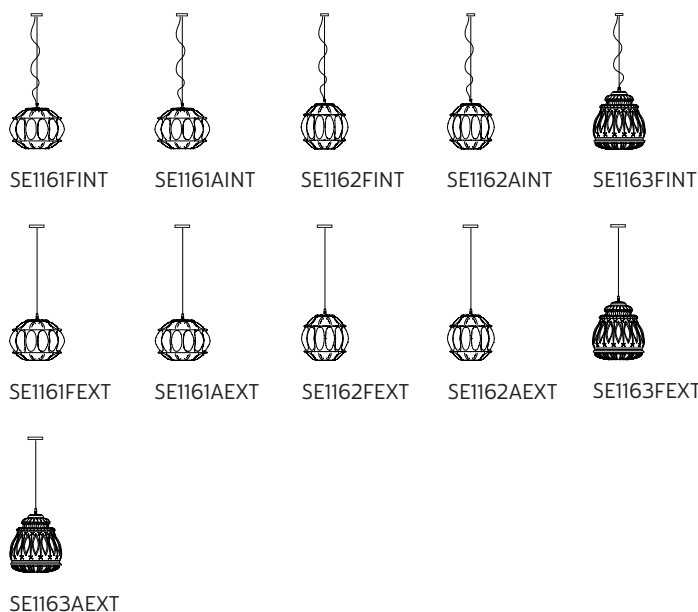

GINGER sospensione

Edmondo Testaguzza design

anno 2015

SCHEDA TECNICA - SE116 3F INT

CORPO LAMPADA "A"

materiale
colore

vetro
fumè



ROSONE "E"

materiale
colore

metallo
trasparente

CAVO ELETTRICO "C"

materiale
colore

telato
nero



FUNE DI SOSPENSIONE "F"

materiale

acciaio

DISPOSITIVO ELETTRICO

portalampade
sorgente luminosa
classe energetica

E27
max 1x77w
da E a A++

PACKAGING

n° colli
peso netto/kg
peso lordo/kg
imballo/cm

1
5
9
47x47x47

EMISSIONE LUMINOSA

unidirezionale

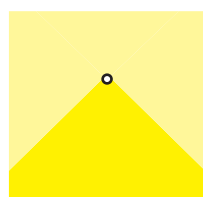

- diretta
- filtrata
- indiretta
- assenza

CERTIFICAZIONI

IEC 60598-1:2008
EN 60598-1:2008 + A11:2009



grado di protezione
lampadina

IP20
non inclusa

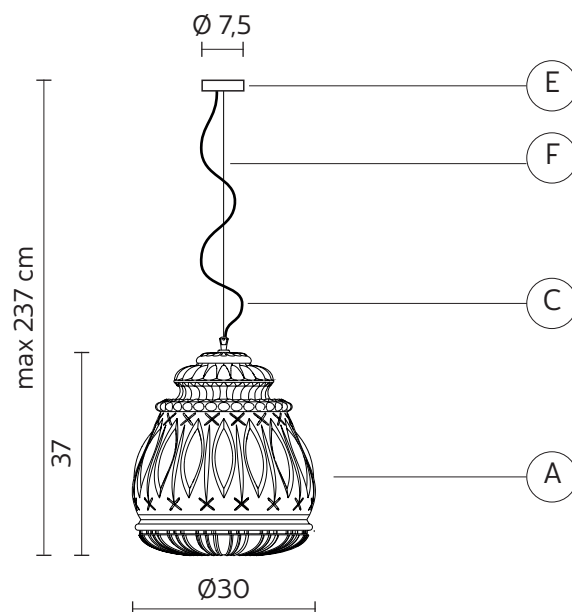

COLLEZIONE

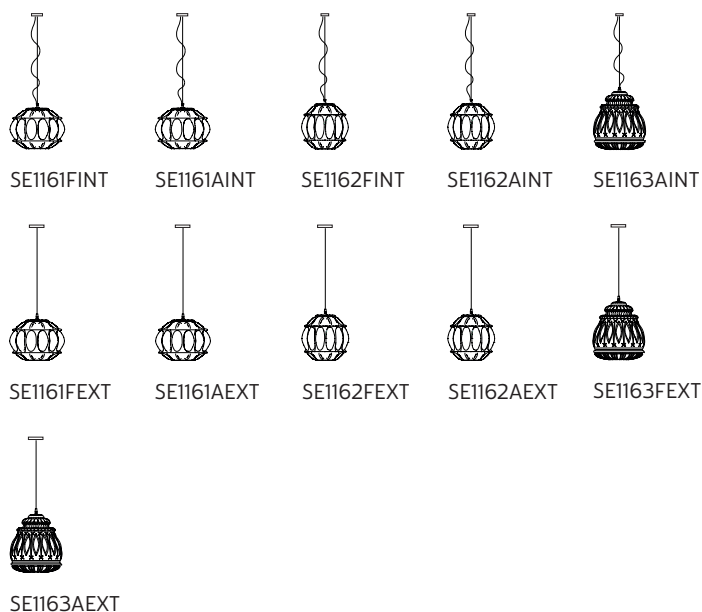

MEK sospensione

Bizzarri design

anno 2015

SCHEMA TECNICA - SE107 1B INT

CORPO LAMPADA "A"

materiale	ceramica	
colore	bianco	

ROSONE "E"

materiale	metallo
colore	bianco opaco

CAVO ELETTRICO "C"

materiale	PVC	
colore	trasparente	

DISPOSITIVO ELETTRICO

portalampane	E27
sorgente luminosa	max 1x105w
classe energetica	da E a A++

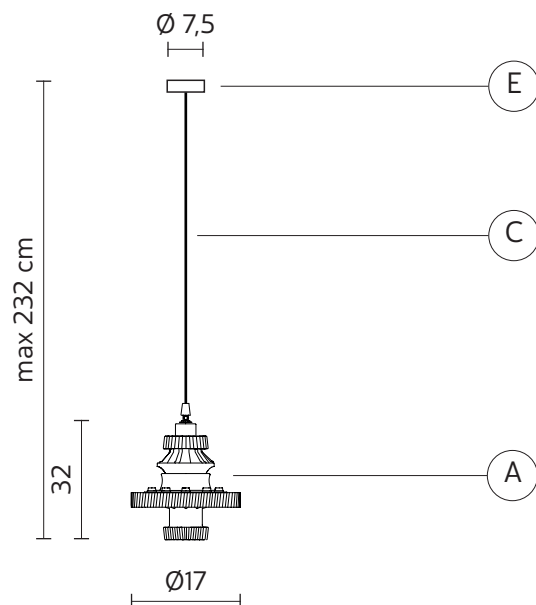

PACKAGING

n° colli	1
peso netto/kg	1,25
peso lordo/kg	2,2
imballo/cm	32x24x32

EMISSIONE LUMINOSA

unidirezionale



CERTIFICAZIONI

IEC	60598-1:2008
EN	60598-1:2008 + A11:2009



grado di protezione lampadina	IP20 opzionale
-------------------------------	-------------------



articolo **700L**
filamenti di tungsteno
E27 - 25w - ≤ 60 lumen
classe E

le lampadine fornite sono solo ed esclusivamente decorative e non di illuminazione.



COLLEZIONE

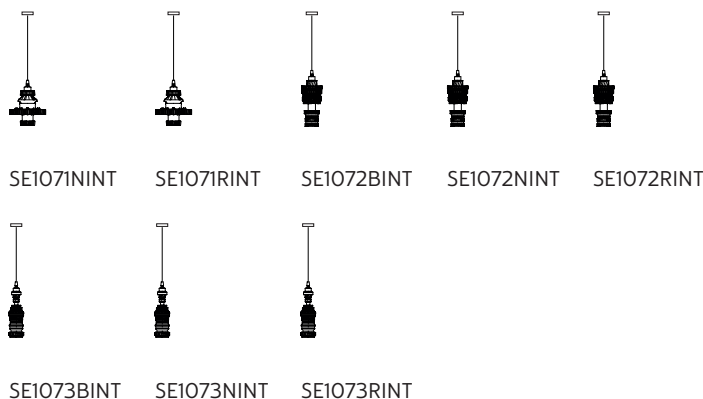

MEK sospensione

Bizzarri design

anno 2015

SCHEDA TECNICA - SE107 1R INT

CORPO LAMPADA "A"

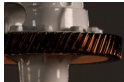
materiale	ceramica	
colore	bianco e bronzo	

ROSONE "E"

materiale	metallo
colore	bianco lucido

CAVO ELETTRICO "C"

materiale	PVC	
colore	trasparente	

DISPOSITIVO ELETTRICO

portalampane	E27
sorgente luminosa	max 1x105w
classe energetica	da E a A++



PACKAGING

n° colli	1
peso netto/kg	1,25
peso lordo/kg	2,2
imballo/cm	32x24x32

EMISSIONE LUMINOSA

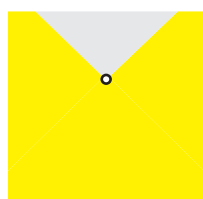
unidirezionale



	diretta
	filtrata
	indiretta
	assenza

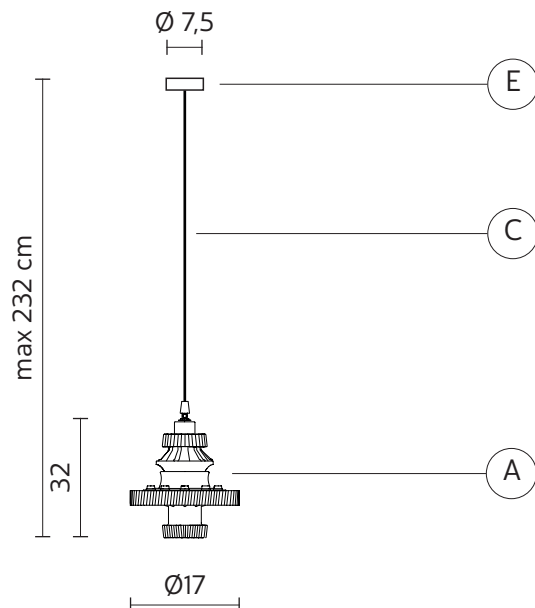

CERTIFICAZIONI

IEC	60598-1:2008
EN	60598-1:2008 + A11:2009



grado di protezione lampadina	IP20 opzionale
-------------------------------	-------------------



articolo **700L**
filamenti di tungsteno
E27 - 25w - ≤ 60 lumen
classe E

le lampadine fornite sono solo ed esclusivamente decorative e non di illuminazione.

COLLEZIONE

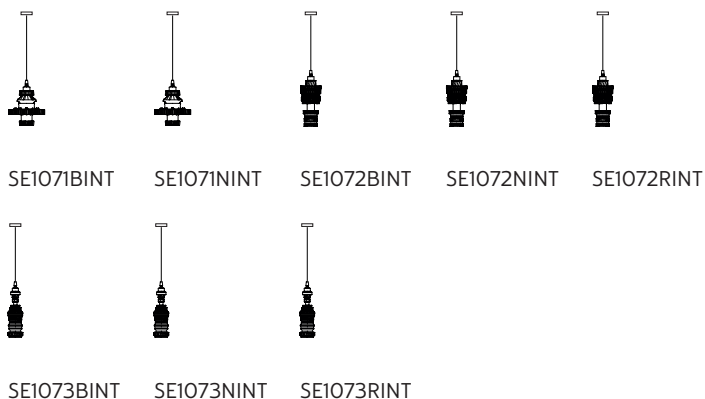

NANDO sospensione

Luca De Bona e Dario De Meo design

anno 2015

SCHEMA TECNICA - SE109 1B INT

CORPO LAMPADA "A"

materiale metallo
colore bianco



ROSONE "E"

materiale metallo
colore RAL 9003 opaco

CAVO ELETTRICO "C"

materiale telaio
colore bianco



DISPOSITIVO ELETTRICO

portalampane E27
sorgente luminosa max 1x77w
classe energetica da E a A++





PACKAGING

n° colli 1
peso netto/kg 1,7
peso lordo/kg 2
imballo/cm 32x25x32

EMISSIONE LUMINOSA

unidirezionale



 diretta
 filtrata
 indiretta
 assenza

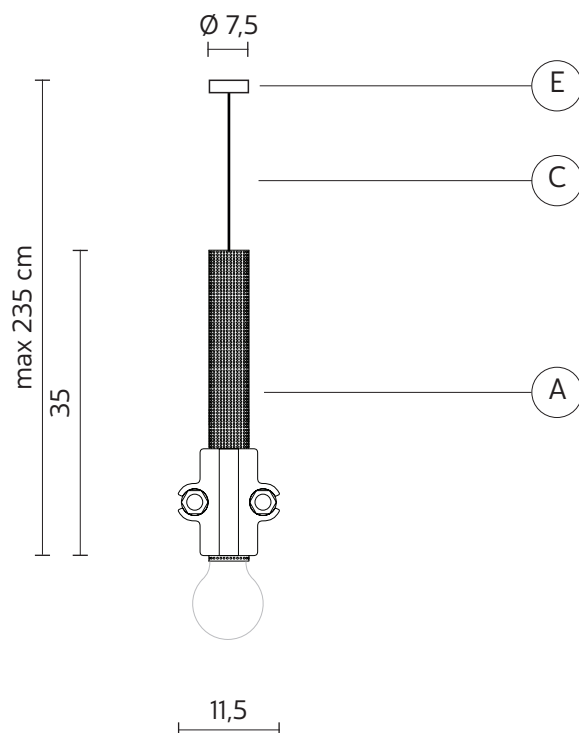

CERTIFICAZIONI

IEC 60598-1:2008
EN 60598-1:2008 + A11:2009



grado di protezione lampadina IP20
opzionale



articolo **700L**
filamenti di tungsteno
E27 - 25w - ≤ 60 lumen
classe E

Le lampadine fornite sono solo ed esclusivamente decorative e non di illuminazione.

COLLEZIONE

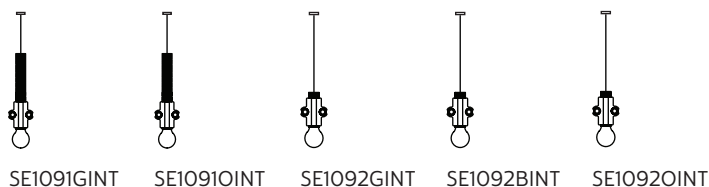

NANDO sospensione

Luca De Bona e Dario De Meo design

anno 2015

SCHEDA TECNICA - SE109 2G INT

CORPO LAMPADA "A"

materiale metallo
colore antracite



ROSONE "E"

materiale metallo
colore nero opaco

CAVO ELETTRICO "C"

materiale telaio
colore nero



DISPOSITIVO ELETTRICO

portalampade E27
sorgente luminosa max 1x77w
classe energetica da E a A++





PACKAGING

n° colli 1
peso netto/kg 1,5
peso lordo/kg 1,7
imballo/cm 21x21x20

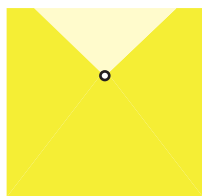
EMISSIONE LUMINOSA

unidirezionale



 diretta
 filtrata
 indiretta
 assenza

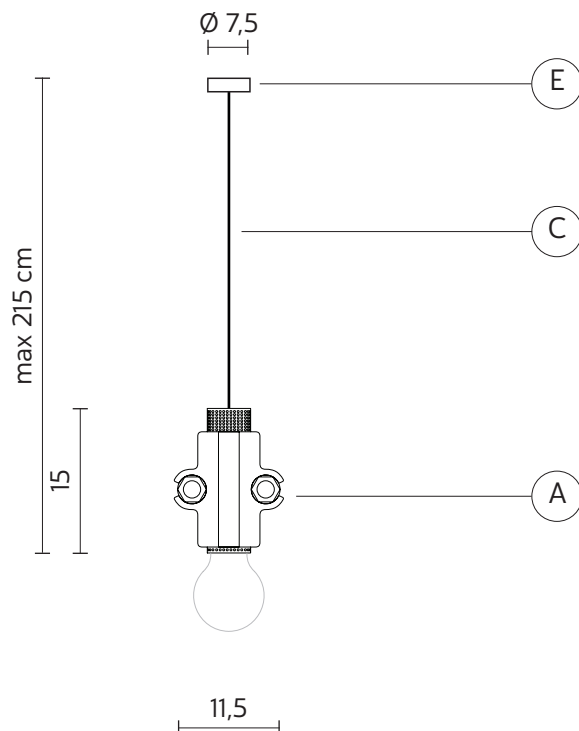

CERTIFICAZIONI

IEC 60598-1:2008
EN 60598-1:2008 + A11:2009



grado di protezione lampadina IP20
opzionale



articolo **700L**
filamenti di tungsteno
E27 - 25w - ≤ 60 lumen
classe E

COLLEZIONE

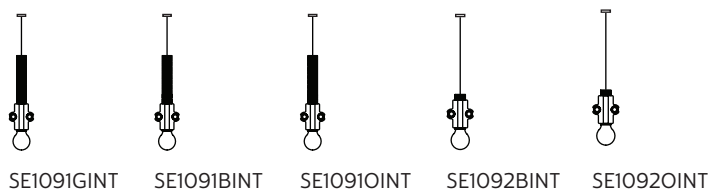

le lampadine fornite sono solo ed esclusivamente decorative e non di illuminazione.

NOTREDAME plafoniera/applique

Luca De Bona & Dario De Meo design

anno 2016

SCHEDA TECNICA - PL130 3B INT

LAMPADA "A"

materiale
colore

tecnopolimero
bianco

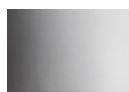

DISPOSITIVO ELETTRICO

sorgente luminosa

LED/strip LED dimmerabile
con dimmer tipo TRIAC a taglio di fase

LED frontale

13W, 1520 lumen 3000K CRI>80

strip LED retroilluminazione

3W, 280 lumen, 3000K CRI>80
classe A+

PACKAGING

n° colli	1
peso netto/kg	8,35
peso lordo/kg	12,2
imballo/cm	105x93x20

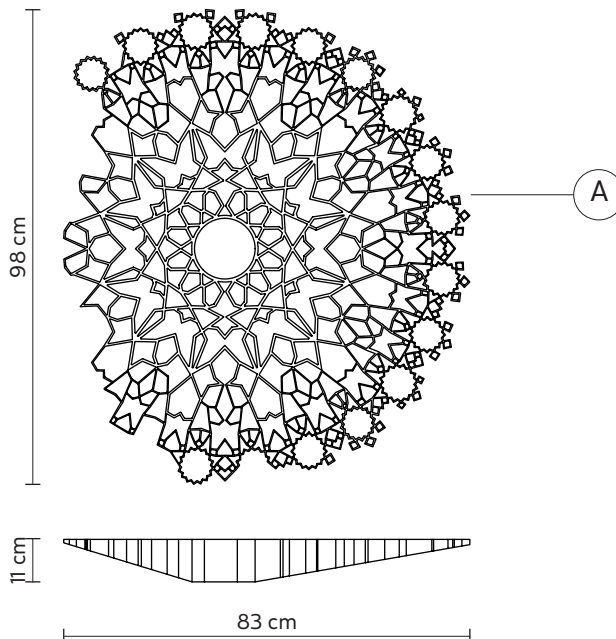

EMISSIONE LUMINOSA

unidirezionale

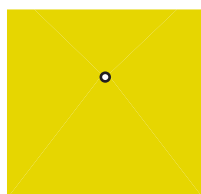

	diretta
	filtrata
	indiretta
	assenza



CONFORME ALLE

IEC 60598-1:2014
EN 60598-1:2015



grado di protezione
lampadina

IP20
Kit LED incluso

COLLEZIONE

disponibili anche nella versione sospensione

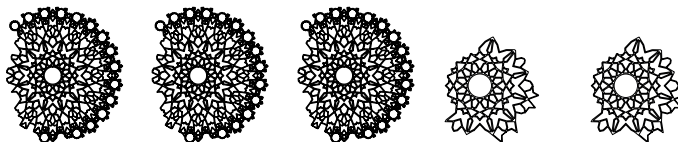

PL130 5B INT PL130 30 INT PL130 50 INT PL130 4B INT PL130 6B INT

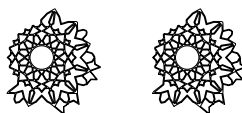

PL130 40 INT PL130 60 INT

OTTAVO lampada da terra

Matteo Ugolini design

anno 2018

SCHEDA TECNICA - HP155 AB EXT

LAMPADA "A"

materiale tecnopolimero
colore bianco opaco



CAVO ELETTRICO "C"

colore nero



DISPOSITIVO ELETTRICO

portalampade GU10
sorgente luminosa 1 x max 7,5W LED
classe energetica da A a A++

PACKAGING

n° colli 1
peso netto/kg 4
peso lordo/kg 5,3
imballo/cm 42x42x80

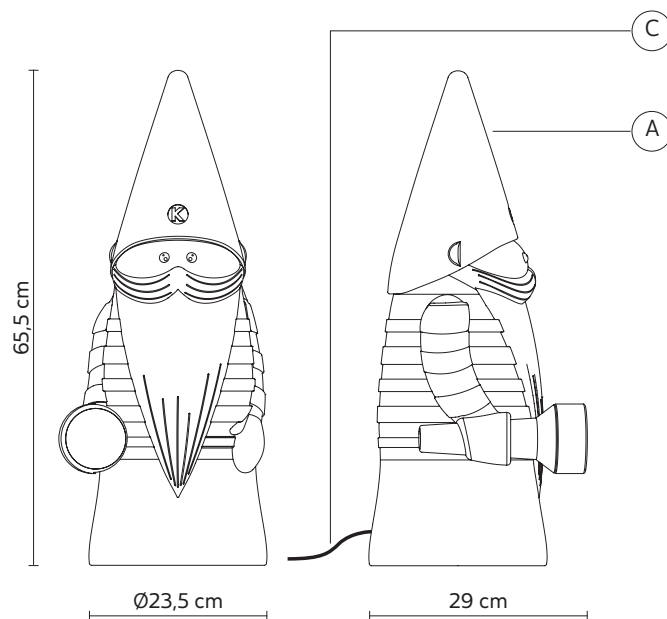

EMISSIONE LUMINOSA

unidirezionale

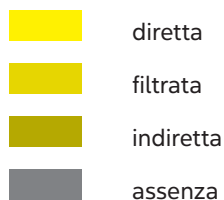
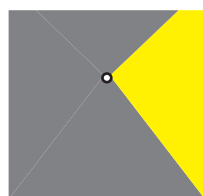

CONFORME ALLE

IEC 60598-1:2014
EN 60598-1:2015



grado di protezione lampadina

IP55
inclusa

1xGU10 LED
7,5W LED, 680lumen
3000K CRI≥80
classe A+

COLLEZIONE

disponibili anche nella versione sospensione e piantana (solo torcia)



HP155 AB INT

QUARANTASEI applique

Matteo Ugolini design

anno 2017

SCHEDA TECNICA - AP140 1G EXT

STRUTTURA "A"

materiale	cemento	
colore	grigio tortora	

DIFFUSORE "B"

materiale	vetro satinato	
-----------	----------------	---

ACCESSORI NUMERI "C"

non inclusi

materiale	acciaio inox
colore	bianco

DISPOSITIVO ELETTRICO

portalampada	R7S
sorgente luminosa	1 x max 8W LED
classe energetica	da A a A+

PACKAGING

n° colli	1
peso netto/kg	3,2
peso lordo/kg	4,1
imballo/cm	36x36x24

EMISSIONE LUMINOSA

unidirezionale



CERTIFICAZIONI

IEC	60598-1:2008
EN	60598-1:2008 + A11:2009



grado di protezione lampadina

IP44	inclusa
1xR7S LED	
8W, 800lumen, 3000K	
classe A+	

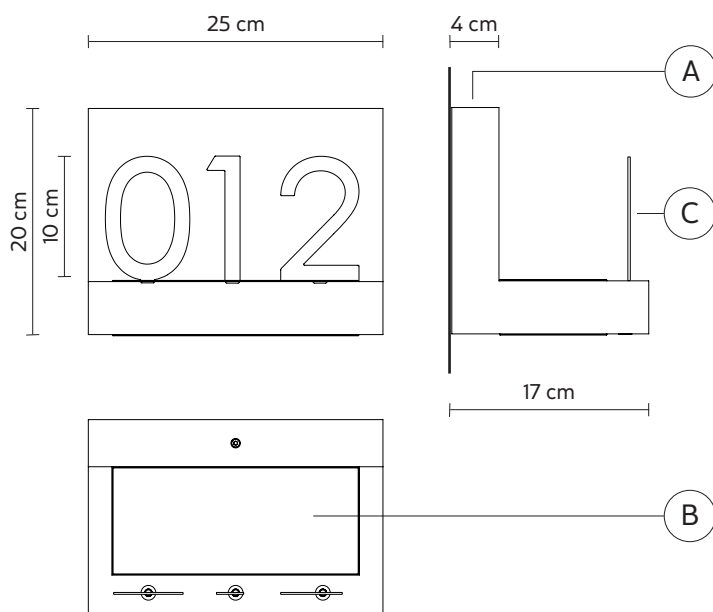

ACCESSORI NUMERI "C" (NON INCLUSI)

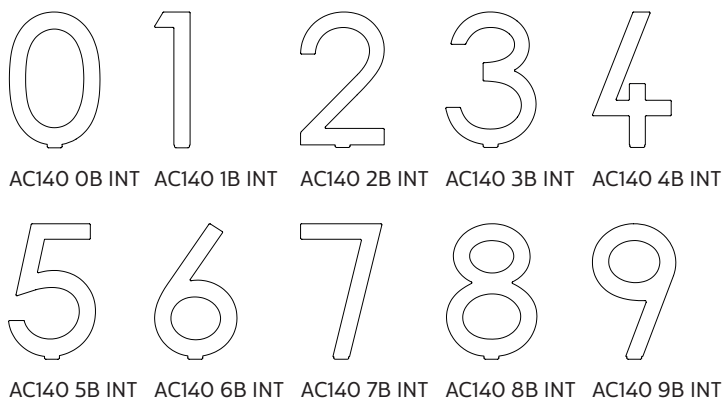

QUARANTASEI applique

Matteo Ugolini design

anno 2017

SCHEDA TECNICA - AP140 1G EXT

STRUTTURA "A"

materiale	cemento	
colore	grigio tortora	

DIFFUSORE "B"

materiale	vetro satinato	
-----------	----------------	---

ACCESSORI NUMERI "C"

non inclusi

materiale	acciaio inox
colore	bianco

DISPOSITIVO ELETTRICO

portalampada	R7S
sorgente luminosa	1 x max 8W LED
classe energetica	da A a A+

PACKAGING

n° colli	1
peso netto/kg	3,2
peso lordo/kg	4,1
imballo/cm	36x36x24

EMISSIONE LUMINOSA

unidirezionale



CERTIFICAZIONI

IEC	60598-1:2008
EN	60598-1:2008 + A11:2009



grado di protezione lampadina

IP44	inclusa
1xR7S LED	
8W, 800lumen, 3000K	
classe A+	

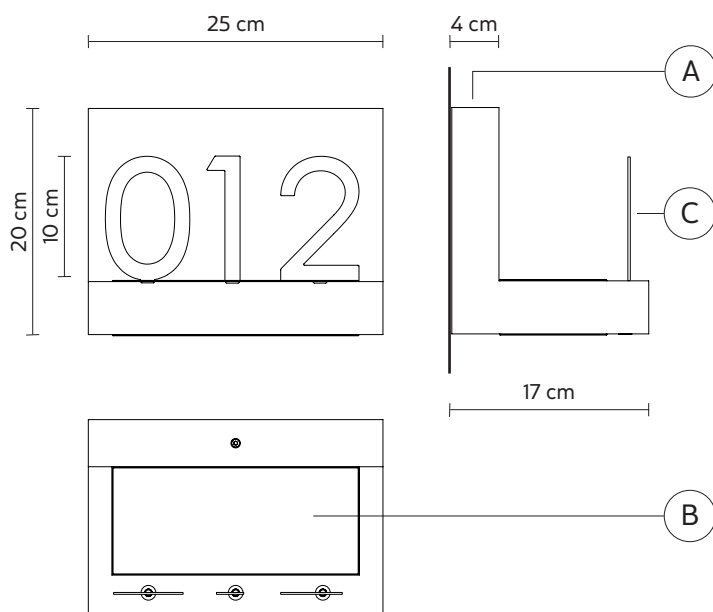

ACCESSORI NUMERI "C" (NON INCLUSI)

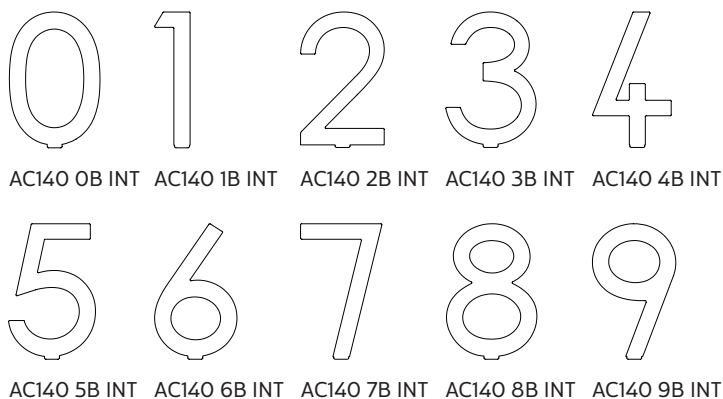

QUARANTASEI applique

Matteo Ugolini design

anno 2017

SCHEDA TECNICA - AP140 1G EXT

STRUTTURA "A"

materiale cemento
colore grigio tortora

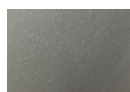

DIFFUSORE "B"

materiale vetro satinato



ACCESSORI NUMERI "C"

non inclusi

materiale acciaio inox
colore bianco

DISPOSITIVO ELETTRICO

portalampada R7S
sorgente luminosa 1 x max 8W LED
classe energetica da A a A+

PACKAGING

n° colli 1
peso netto/kg 3,2
peso lordo/kg 4,1
imballo/cm 36x36x24

EMISSIONE LUMINOSA

unidirezionale

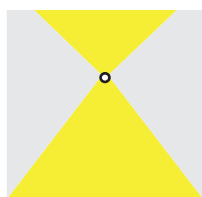

■ diretta
■ filtrata
■ indiretta
■ assenza

CERTIFICAZIONI

IEC 60598-1:2008
EN 60598-1:2008 + A11:2009



grado di protezione lampadina IP44
inclusa

1xR7S LED
8W, 800lumen, 3000K
classe A+

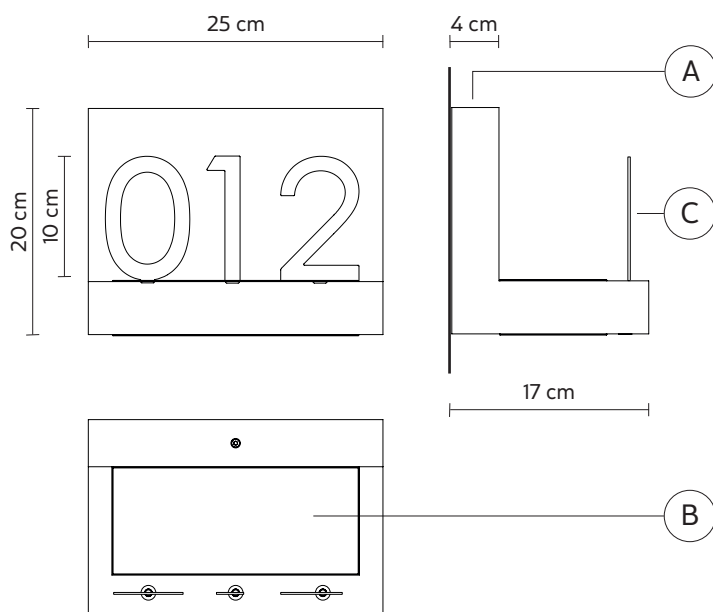

ACCESSORI NUMERI "C" (NON INCLUSI)



AC140 0B INT AC140 1B INT AC140 2B INT AC140 3B INT AC140 4B INT



AC140 5B INT AC140 6B INT AC140 7B INT AC140 8B INT AC140 9B INT

QUARANTASEI applique

Matteo Ugolini design

anno 2017

SCHEDA TECNICA - AP140 1G EXT

STRUTTURA "A"

materiale	cemento	
colore	grigio tortora	

DIFFUSORE "B"

materiale	vetro satinato	
-----------	----------------	---

ACCESSORI NUMERI "C"

non inclusi

materiale	acciaio inox
colore	bianco

DISPOSITIVO ELETTRICO

portalampada	R7S
sorgente luminosa	1 x max 8W LED
classe energetica	da A a A+

PACKAGING

n° colli	1
peso netto/kg	3,2
peso lordo/kg	4,1
imballo/cm	36x36x24

EMISSIONE LUMINOSA

unidirezionale



CERTIFICAZIONI

IEC	60598-1:2008
EN	60598-1:2008 + A11:2009



grado di protezione lampadina

IP44
inclusa

1xR7S LED
8W, 800lumen, 3000K
classe A+

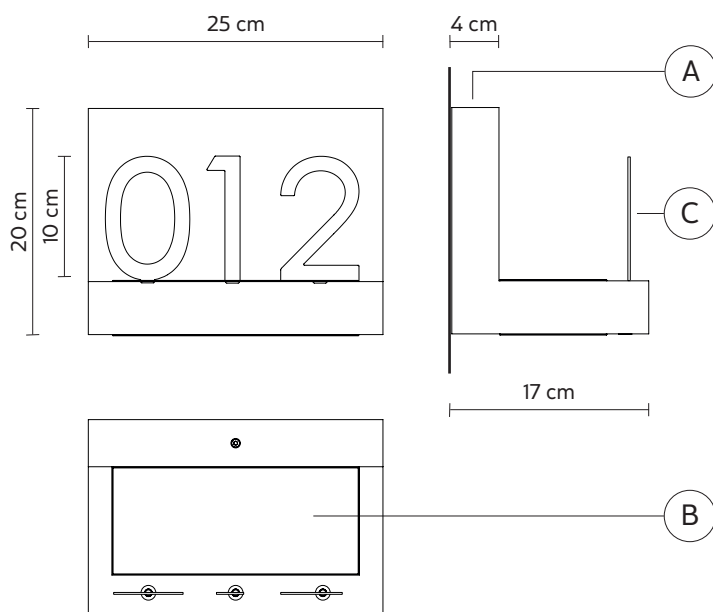

ACCESSORI NUMERI "C" (NON INCLUSI)



QUARANTASEI applique

Matteo Ugolini design

anno 2017

SCHEDA TECNICA - AP140 1G EXT

STRUTTURA "A"

materiale cemento
colore grigio tortora

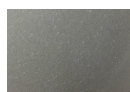

DIFFUSORE "B"

materiale vetro satinato



ACCESSORI NUMERI "C"

non inclusi

materiale acciaio inox
colore bianco

DISPOSITIVO ELETTRICO

portalampada R7S
sorgente luminosa 1 x max 8W LED
classe energetica da A a A+

PACKAGING

n° colli 1
peso netto/kg 3,2
peso lordo/kg 4,1
imballo/cm 36x36x24

EMISSIONE LUMINOSA

unidirezionale

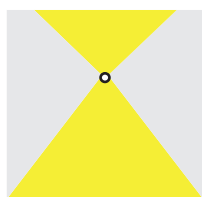

diretta
filtrata
indiretta
assenza

CERTIFICAZIONI

IEC 60598-1:2008
EN 60598-1:2008 + A11:2009



grado di protezione lampadina IP44
inclusa

1xR7S LED
8W, 800lumen, 3000K
classe A+

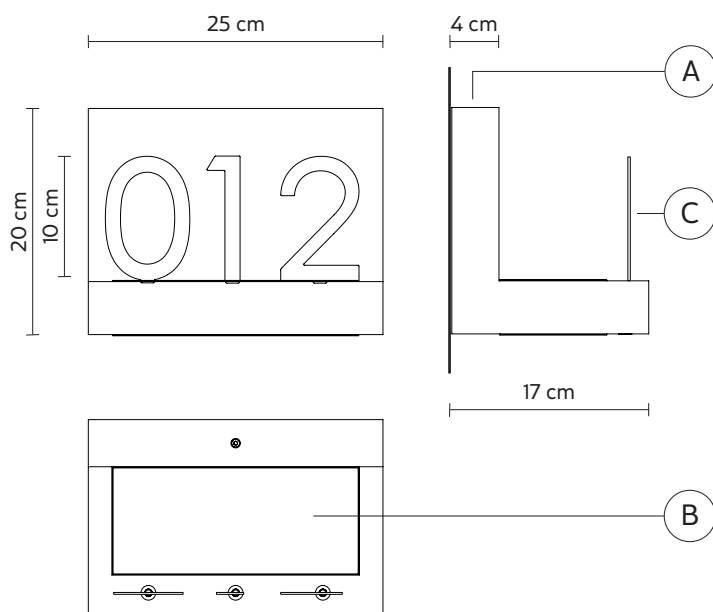

ACCESSORI NUMERI "C" (NON INCLUSI)



AC140 0B INT AC140 1B INT AC140 2B INT AC140 3B INT AC140 4B INT



AC140 5B INT AC140 6B INT AC140 7B INT AC140 8B INT AC140 9B INT

QUARANTASEI applique

Matteo Ugolini design

anno 2017

SCHEDA TECNICA - AP140 1G EXT

STRUTTURA "A"

materiale	cemento	
colore	grigio tortora	

DIFFUSORE "B"

materiale	vetro satinato	
-----------	----------------	---

ACCESSORI NUMERI "C"

non inclusi

materiale	acciaio inox
colore	bianco

DISPOSITIVO ELETTRICO

portalampada	R7S
sorgente luminosa	1 x max 8W LED
classe energetica	da A a A+

PACKAGING

n° colli	1
peso netto/kg	3,2
peso lordo/kg	4,1
imballo/cm	36x36x24

EMISSIONE LUMINOSA

unidirezionale



CERTIFICAZIONI

IEC	60598-1:2008
EN	60598-1:2008 + A11:2009



grado di protezione lampadina

IP44
inclusa

1xR7S LED
8W, 800lumen, 3000K
classe A+

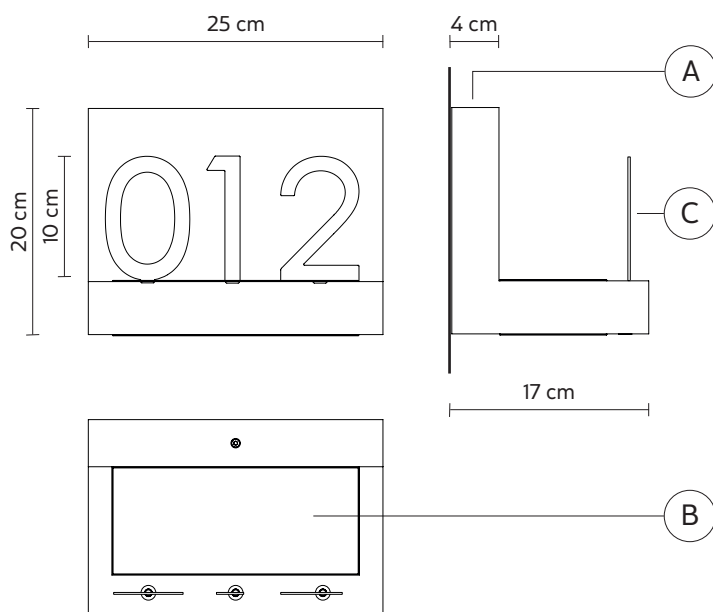

ACCESSORI NUMERI "C" (NON INCLUSI)

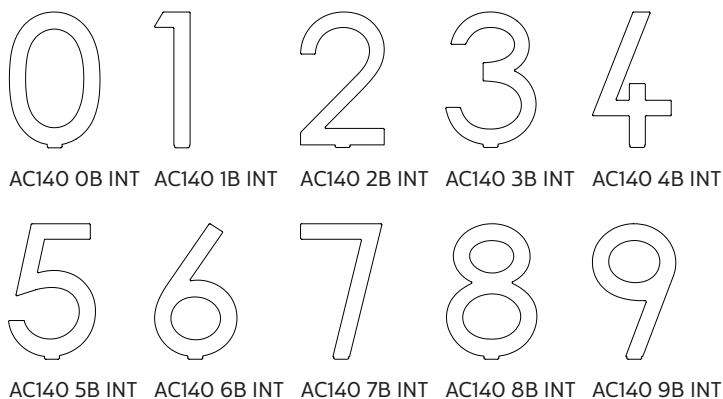

QUARANTASEI applique

Matteo Ugolini design

anno 2017

SCHEDA TECNICA - AP140 1G EXT

STRUTTURA "A"

materiale cemento
colore grigio tortora

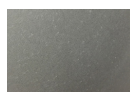

DIFFUSORE "B"

materiale vetro satinato



ACCESSORI NUMERI "C"

non inclusi

materiale acciaio inox
colore bianco

DISPOSITIVO ELETTRICO

portalampada R7S
sorgente luminosa 1 x max 8W LED
classe energetica da A a A+

PACKAGING

n° colli 1
peso netto/kg 3,2
peso lordo/kg 4,1
imballo/cm 36x36x24

EMISSIONE LUMINOSA

unidirezionale

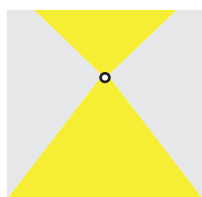

■ diretta
■ filtrata
■ indiretta
■ assenza

CERTIFICAZIONI

IEC 60598-1:2008
EN 60598-1:2008 + A11:2009



grado di protezione lampadina IP44
inclusa

1xR7S LED
8W, 800lumen, 3000K
classe A+

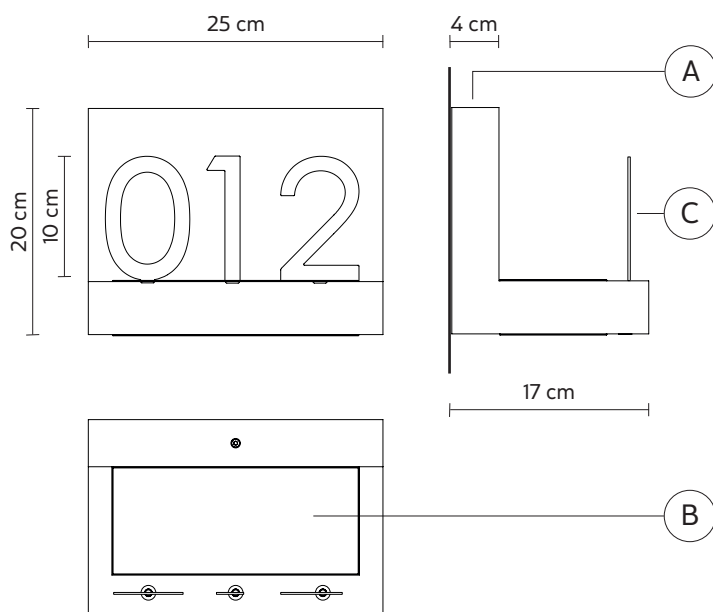

ACCESSORI NUMERI "C" (NON INCLUSI)



AC140 0B INT AC140 1B INT AC140 2B INT AC140 3B INT AC140 4B INT



AC140 5B INT AC140 6B INT AC140 7B INT AC140 8B INT AC140 9B INT

QUARANTASEI applique

Matteo Ugolini design

anno 2017

SCHEDA TECNICA - AP140 1G EXT

STRUTTURA "A"

materiale cemento
colore grigio tortora

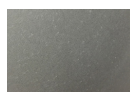

DIFFUSORE "B"

materiale vetro satinato



ACCESSORI NUMERI "C"

non inclusi

materiale acciaio inox
colore bianco

DISPOSITIVO ELETTRICO

portalampada R7S
sorgente luminosa 1 x max 8W LED
classe energetica da A a A+

PACKAGING

n° colli 1
peso netto/kg 3,2
peso lordo/kg 4,1
imballo/cm 36x36x24

EMISSIONE LUMINOSA

unidirezionale

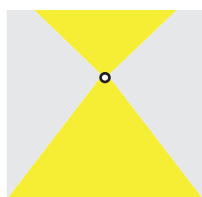

■ diretta
■ filtrata
■ indiretta
■ assenza

CERTIFICAZIONI

IEC 60598-1:2008
EN 60598-1:2008 + A11:2009



grado di protezione lampadina

IP44
inclusa

1xR7S LED
8W, 800lumen, 3000K
classe A+

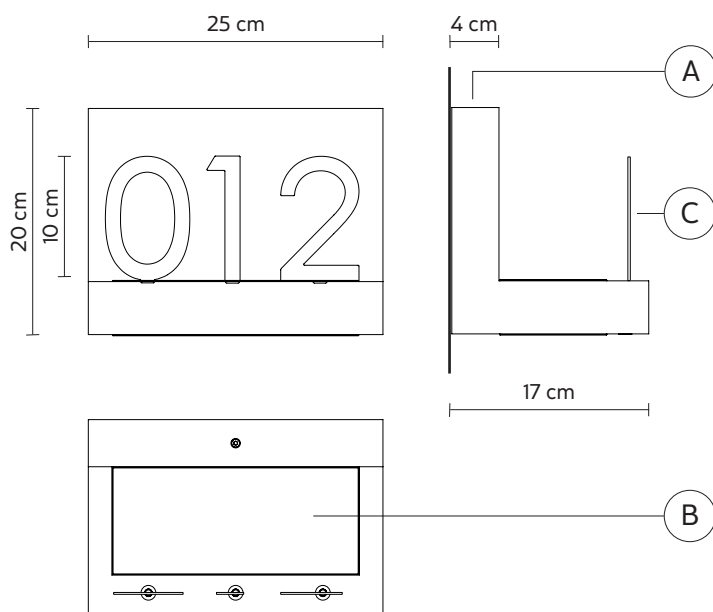

ACCESSORI NUMERI "C" (NON INCLUSI)



AC140 0B INT AC140 1B INT AC140 2B INT AC140 3B INT AC140 4B INT



AC140 5B INT AC140 6B INT AC140 7B INT AC140 8B INT AC140 9B INT

QUARANTASEI applique

Matteo Ugolini design

anno 2017

SCHEDA TECNICA - AP140 1G EXT

STRUTTURA "A"

materiale	cemento	
colore	grigio tortora	

DIFFUSORE "B"

materiale	vetro satinato	
-----------	----------------	---

ACCESSORI NUMERI "C"

non inclusi

materiale	acciaio inox
colore	bianco

DISPOSITIVO ELETTRICO

portalampada	R7S
sorgente luminosa	1 x max 8W LED
classe energetica	da A a A+

PACKAGING

n° colli	1
peso netto/kg	3,2
peso lordo/kg	4,1
imballo/cm	36x36x24

EMISSIONE LUMINOSA

unidirezionale



CERTIFICAZIONI

IEC	60598-1:2008
EN	60598-1:2008 + A11:2009



grado di protezione lampadina

IP44
inclusa
1xR7S LED
8W, 800lumen, 3000K
classe A+

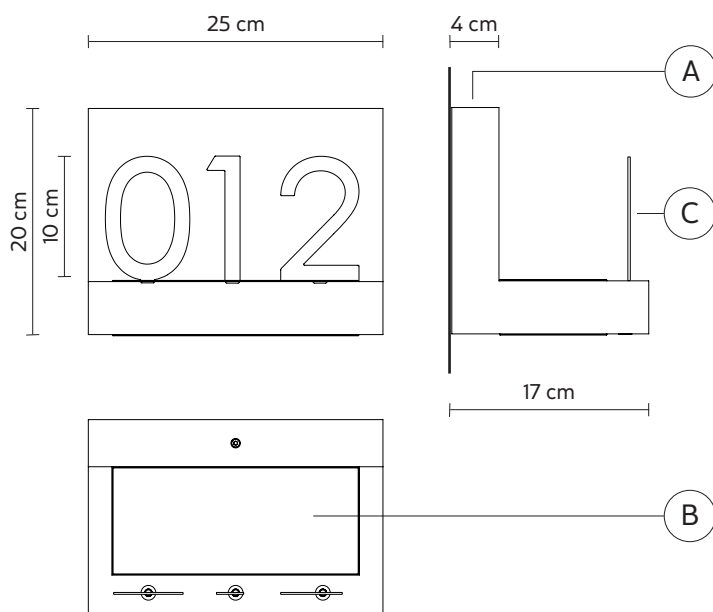

ACCESSORI NUMERI "C" (NON INCLUSI)

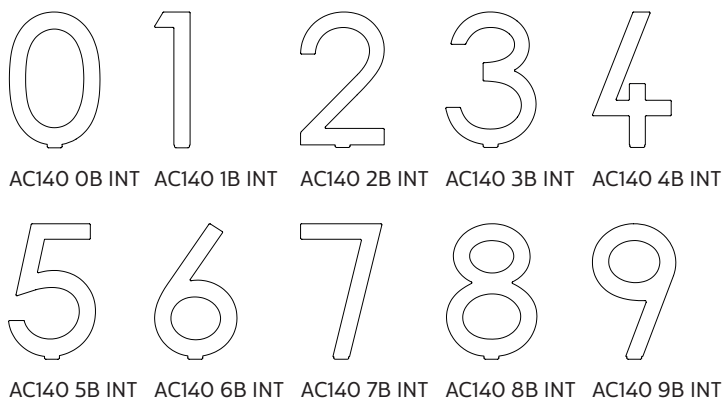

QUARANTASEI applique

Matteo Ugolini design

anno 2017

SCHEDA TECNICA - AP140 1G EXT

STRUTTURA "A"

materiale cemento
colore grigio tortora

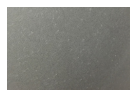

DIFFUSORE "B"

materiale vetro satinato



ACCESSORI NUMERI "C"

non inclusi

materiale acciaio inox
colore bianco

DISPOSITIVO ELETTRICO

portalampada R7S
sorgente luminosa 1 x max 8W LED
classe energetica da A a A+

PACKAGING

n° colli 1
peso netto/kg 3,2
peso lordo/kg 4,1
imballo/cm 36x36x24

EMISSIONE LUMINOSA

unidirezionale

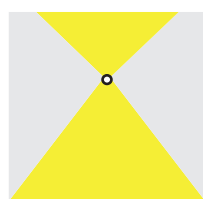

■ diretta
■ filtrata
■ indiretta
■ assenza

CERTIFICAZIONI

IEC 60598-1:2008
EN 60598-1:2008 + A11:2009



grado di protezione lampadina

IP44
inclusa

1xR7S LED
8W, 800lumen, 3000K
classe A+

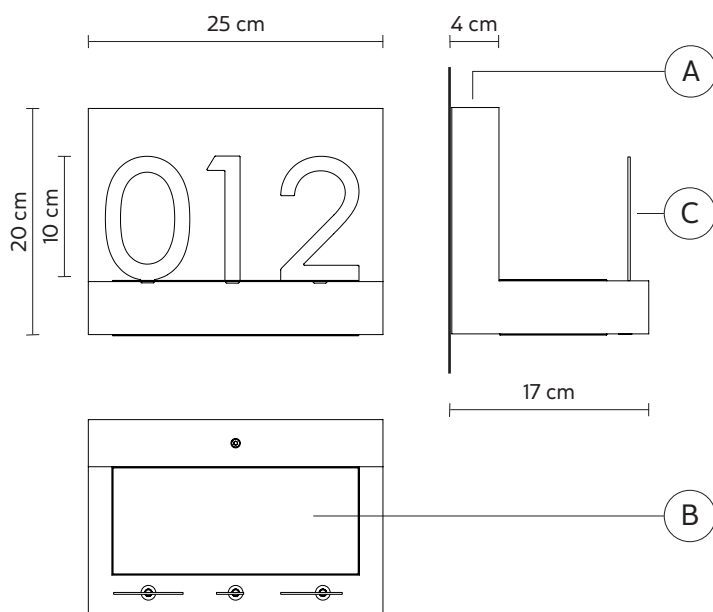

ACCESSORI NUMERI "C" (NON INCLUSI)



AC140 0B INT AC140 1B INT AC140 2B INT AC140 3B INT AC140 4B INT



AC140 5B INT AC140 6B INT AC140 7B INT AC140 8B INT AC140 9B INT

QUARANTASEI applique

Matteo Ugolini design

anno 2017

SCHEDA TECNICA - AP140 1G EXT

STRUTTURA "A"

materiale	cemento	
colore	grigio tortora	

DIFFUSORE "B"

materiale	vetro satinato	
-----------	----------------	---

ACCESSORI NUMERI "C"

non inclusi

materiale	acciaio inox
colore	bianco

DISPOSITIVO ELETTRICO

portalampada	R7S
sorgente luminosa	1 x max 8W LED
classe energetica	da A a A+

PACKAGING

n° colli	1
peso netto/kg	3,2
peso lordo/kg	4,1
imballo/cm	36x36x24

EMISSIONE LUMINOSA

unidirezionale



CERTIFICAZIONI

IEC	60598-1:2008
EN	60598-1:2008 + A11:2009
	    

grado di protezione lampadina

IP44	inclusa
1xR7S LED	
8W, 800lumen, 3000K	
classe A+	

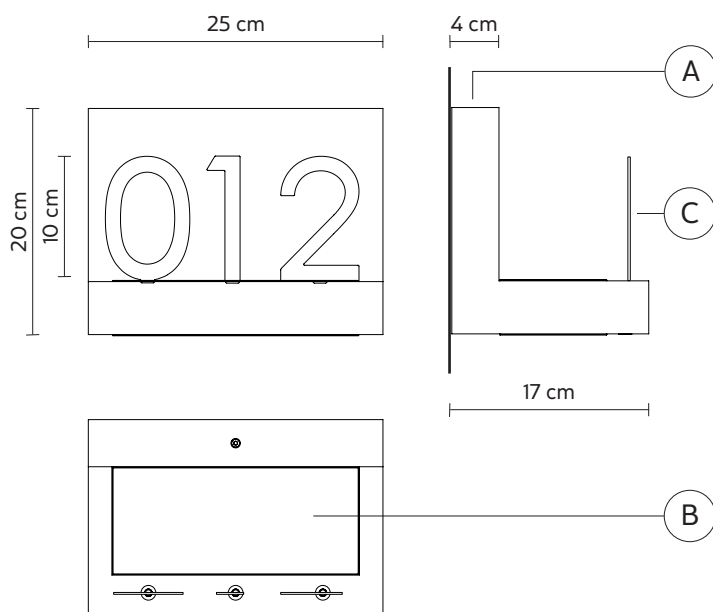

ACCESSORI NUMERI "C" (NON INCLUSI)



SHERWOOD E ROBIN sospensione

Matteo Ugolini design

anno 2018

SCHEDA TECNICA - SE151 BB INT

LAMPADA "A"

materiale
ceramica
colore
bianco opaco



ROBIN "R"

materiale
ceramica
colore
bianco opaco



ROSONE "E"

materiale
metallo
colore
bianco opaco

CAVO ELETTRICO "C"

colore
bianco telato



DISPOSITIVO ELETTRICO

portalampane
E27
sorgente luminosa
1 x max 53W
classe energetica
da E a A++

PACKAGING

n° colli
2
peso netto/kg
1,35 (A+R)
peso lordo/kg
2,2 (A+R)
imballo/cm
21x21x20 (A) - 28x28x45 (R)

EMISSIONE LUMINOSA

unidirezionale

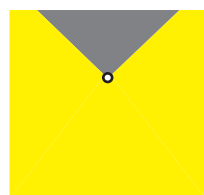

 diretta
 filtrata
 indiretta
 assenza

CONFORME ALLE

IEC
60598-1:2014
EN
60598-1:2015



grado di protezione
lampadine
IP20
opzionale



700L*
1xE27 - 25/40W 60lumen
220/240V
classe A+

***le lampadine fornite sono solo ed esclusivamente decorative e non di illuminazione**

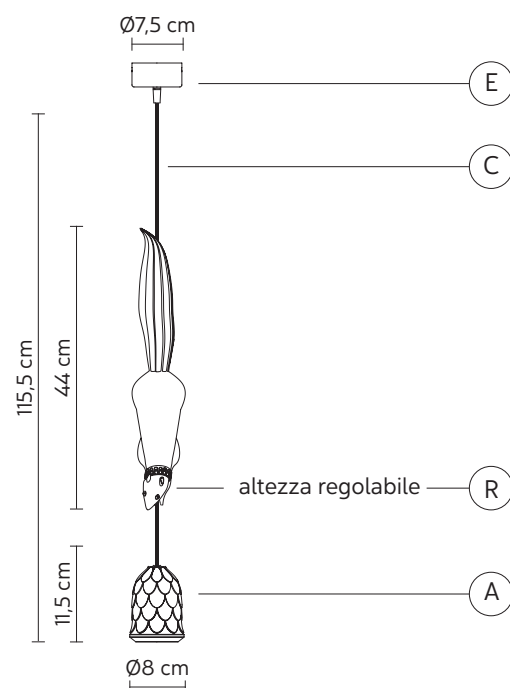

COLLEZIONE



CORPO LAMPADA "A"

materiale
colore

ceramica
bianca opaca



DISPOSITIVO ELETTRICO

portalampade
sorgente luminosa
classe energetica

E27
max 2x53w
da E a A++

PACKAGING

n° colli
peso netto/kg
peso lordo/kg
imballo/cm

1
3,8
8
45x55x35

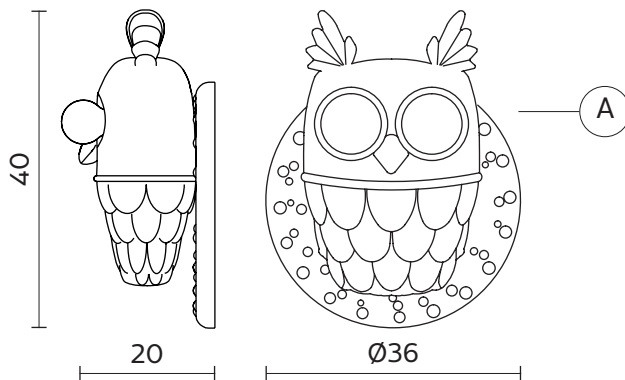

EMISSIONE LUMINOSA

unidirezionale



■ diretta
■ filtrata
■ indiretta
■ assenza

CERTIFICAZIONI

IEC
EN

60598-1:2008
60598-1:2008 + A11:2009



grado di protezione
lampadina

IP20
opzionale



articolo **700B**
filamenti di tungsteno
E27 - 25/40w - ≤ 60 lumen
classe E



disponibili anche nella versione da tavolo

Le lampadine fornite sono solo ed esclusivamente decorative e non di illuminazione.

TI VEDO lampada da tavolo

Matteo Ugolini design

anno 2015

SCHEDA TECNICA - CT105 1B INT

CORPO LAMPADA "A"

materiale
ceramica
colore
bianco opaco



CAVO ELETTRICO

materiale
PVC
colore
trasparente



DISPOSITIVO ELETTRICO

portalampane
E27
sorgente luminosa
max 2x53w
classe energetica
da E a A++

PACKAGING



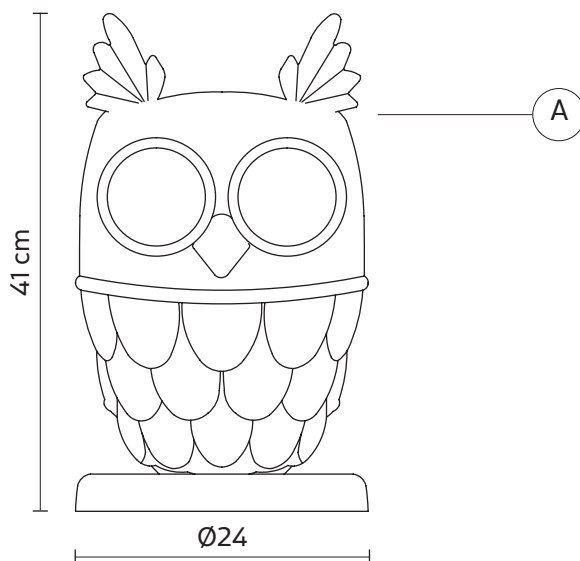

n° colli
1
peso netto/kg
3,3
peso lordo/kg
6,8
imballo/cm
40x40x50

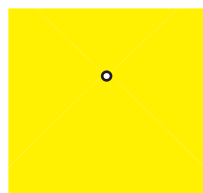

EMISSIONE LUMINOSA

unidirezionale



 diretta
 filtrata
 indiretta
 assenza

CERTIFICAZIONI

IEC
EN
60598-1:2008
60598-1:2008 + A11:2009



grado di protezione
lampadina

IP20
opzionale



articolo **700B**
filamenti di tungsteno
E27 - 25/40w - ≤ 60 lumen
classe E



disponibili anche nella versione applique

Le lampadine fornite sono solo ed esclusivamente decorative e non di illuminazione.

TOBIA piantana

Edmondo Testaguzza design

anno 2017

SCHEDA TECNICA - HP145 1F EXT

CORPO LAMPADA "A"

materiale tecnopolimero
colore bianco



CAVO ELETTRICO

colore nero



DISPOSITIVO ELETTRICO

sorgente luminosa LED
17,2W, 1550lumen, 3000K
classe A+

PACKAGING

n° colli 1
peso netto/kg 3,6
peso lordo/kg 7,5
imballo/cm 190x40x40

ACCESSORIO GANCIO A PARETE - AC143 4A INT

non incluso

materiale acciaio spazzolato



ACCESSORIO PIEDISTALLO PIANTANA - AC143 5A INT

non incluso





materiale acciaio inox

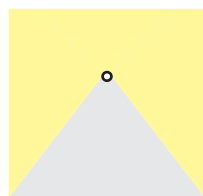

EMISSIONE LUMINOSA

unidirezionale



 diretta
 filtrata
 indiretta
 assenza

CERTIFICAZIONI

IEC 60598-1:2008
EN 60598-1:2008 + A11:2009



grado di protezione IP65
LED incluso

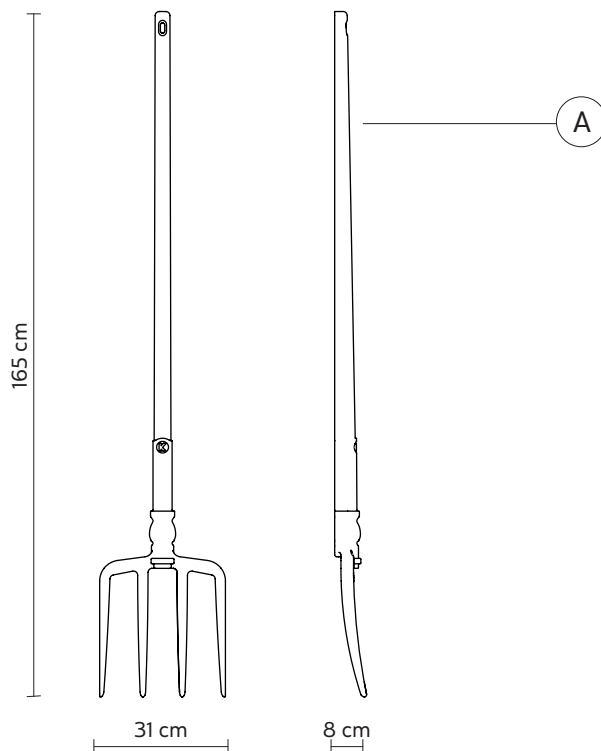

COLLEZIONE

disponibili anche nella versione da interno

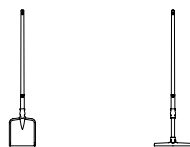

HP145 2P EXT HP145 3R EXT

TOBIA piantana

Edmondo Testaguzza design

anno 2017

SCHEDA TECNICA - HP145 2P EXT

CORPO LAMPADA "A"

materiale tecnopolimero
colore bianco



CAVO ELETTRICO

colore nero



DISPOSITIVO ELETTRICO

sorgente luminosa LED
17,2W, 1550lumen, 3000K
classe A+

PACKAGING

n° colli 1
peso netto/kg 4,3
peso lordo/kg 8,2
imballo/cm 190x40x40

ACCESSORIO GANCIO A PARETE - AC143 4A INT

non incluso

materiale acciaio spazzolato



ACCESSORIO PIEDISTALLO PIANTANA - AC143 5A INT

non incluso





materiale acciaio inox

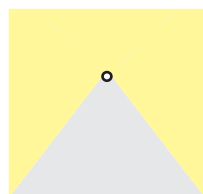

EMISSIONE LUMINOSA

unidirezionale



 diretta
 filtrata
 indiretta
 assenza

CERTIFICAZIONI

IEC 60598-1:2008
EN 60598-1:2008 + A11:2009



grado di protezione IP65
LED incluso

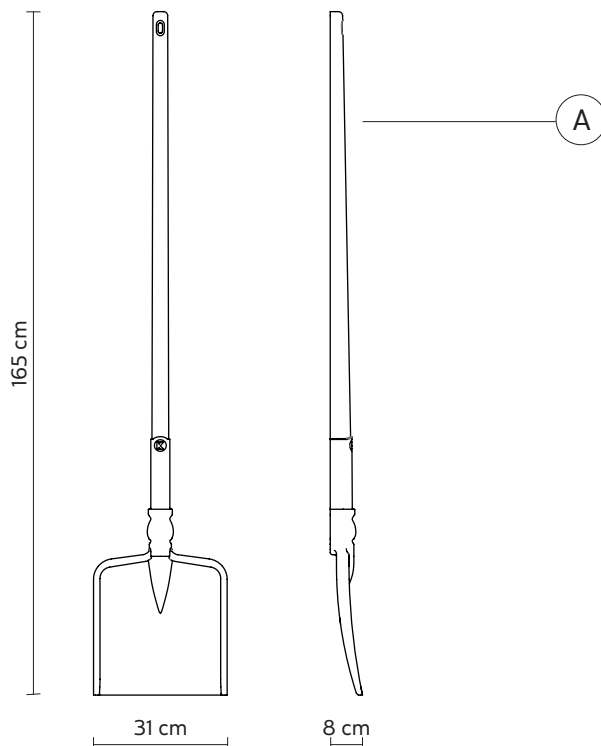

COLLEZIONE

disponibili anche nella versione da interno



HP145 1F EXT



HP145 3R EXT

TOBIA piantana

Edmondo Testaguzza design

anno 2017

SCHEDA TECNICA - HP145 3R EXT

CORPO LAMPADA "A"

materiale tecnopolimero
colore bianco



CAVO ELETTRICO

colore nero



DISPOSITIVO ELETTRICO

sorgente luminosa LED
17,2W, 1550lumen, 3000K
classe A+

PACKAGING

n° colli 1
peso netto/kg 4
peso lordo/kg 7,8
imballo/cm 190x40x50

ACCESSORIO GANCIO A PARETE - AC143 4A INT

non incluso

materiale acciaio spazzolato



ACCESSORIO PIEDISTALLO PIANTANA - AC143 5A INT

non incluso

materiale acciaio inox



EMISSIONE LUMINOSA

unidirezionale



■ diretta
■ filtrata
■ indiretta
■ assenza

CERTIFICAZIONI

IEC 60598-1:2008
EN 60598-1:2008 + A11:2009



grado di protezione IP65
LED incluso

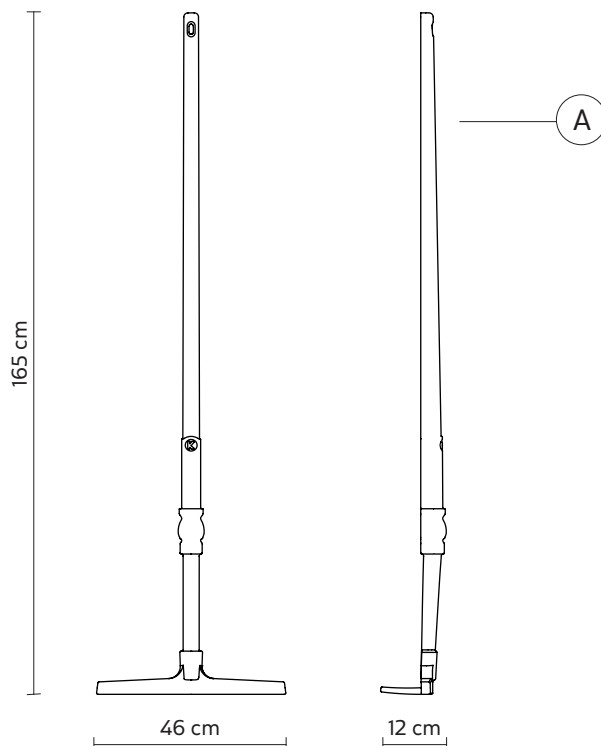

COLLEZIONE

disponibili anche nella versione da interno

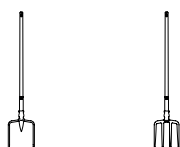

HP145 2P EXT HP145 1F EXT

UGO RILLA applique

Matteo Ugolini design

anno 2018

SCHEDA TECNICA - AP152 BB INT

LAMPADA "A"

materiale
ceramica
colore
bianco opaco

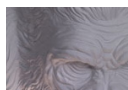

CAVO ELETTRICO "C"

colore
bianco telato



DISPOSITIVO ELETTRICO

portalampade
E27
sorgente luminosa
3 x max 10W LED*
classe energetica
da A a A++

*consigliamo l'utilizzo
di lampadine in plastica



PACKAGING

n° colli
1
peso netto/kg
5,2
peso lordo/kg
6,4
imballo/cm
51x51x32

EMISSIONE LUMINOSA

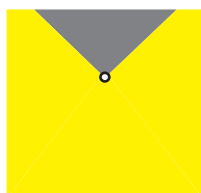
unidirezionale



 diretta
 filtrata
 indiretta
 assenza

CONFORME ALLE

IEC
EN
60598-1:2014
60598-1:2015



grado di protezione
lampadine

IP20
opzionale

700U
1xE27 - 10W LED, 900lumen
2700K, CRI>80 non dimmerabile
220/240V
classe A+

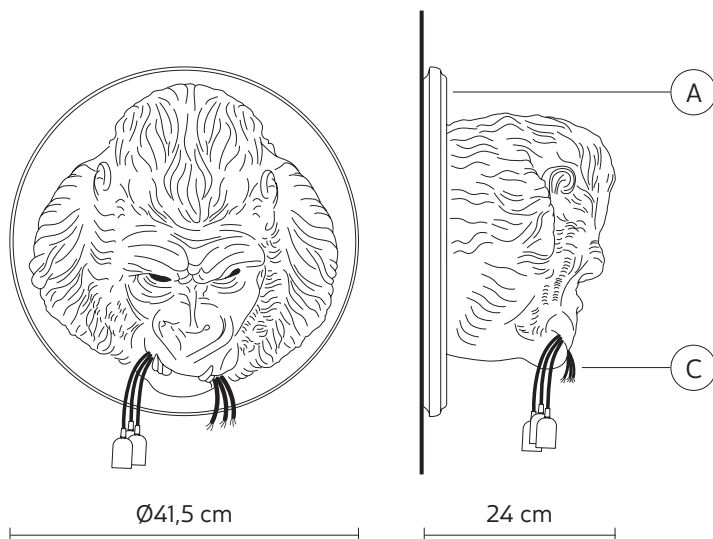

COLLEZIONE



AP152 GR INT

VA-LENTINA applique

Matteo Ugolini design

anno 2015

SCHEDA TECNICA - AP115 OB INT

CORPO LAMPADA "A"

materiale alluminio
colore bianco



DISPOSITIVO ELETTRICO

sorgente luminosa modulo LED 18w,
1800 lumen,
3000 K°
classe energetica da A a A++





PACKAGING

n° colli 1
peso netto/kg 1,8
peso lordo/kg 1,55
imballo/cm 32x25x32

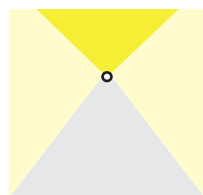
EMISSIONE LUMINOSA

unidirezionale



 diretta
 filtrata
 indiretta
 assenza

CERTIFICAZIONI

IEC 60598-1:2008
EN 60598-1:2008 + A11:2009



grado di protezione lampadina

IP20
Kit LED incluso

